



2013-17

OFFICIAL RULES

OF

ICE HOCKEY

**THE OFFICIAL
RULES OF
ICE HOCKEY**



Typographer: Dana Ausec

Front cover photo courtesy of USA Hockey, Inc.

Interior photography courtesy of USA Hockey, Inc.

© 2013 by USA Hockey, Inc. All rights reserved. Any dissemination, distribution, publication, or copying of rules without the express written consent of USA Hockey is strictly prohibited.

The USA Hockey, Inc. logo is a registered trademark of USA Hockey, Inc., and use in any manner is prohibited unless approval is obtained from the organization.

For more information about ice hockey and ordering more copies of the *Official Rules of Ice Hockey*, contact:

USA Hockey, Inc.

1775 Bob Johnson Drive

Colorado Springs, CO 80906-4090

Telephone (719) 576-8724 Fax (719) 538-1160



USA Hockey is the National Governing Body
for the sport of ice hockey in the United States.

Contents

PREFACE

Points of Emphasis	vii
Standard of Play and Rule Emphasis – Body Checking	ix
Standard of Play and Rule Emphasis – Restraining Fouls	xii
Philosophy of Youth/Girls' Hockey	xv
Codes of Conduct	xvi
Zero Tolerance Policy	xx
Note to Reader	xxi

SECTION ONE

The Rink	1
----------------	---

SECTION TWO

Teams	9
-------------	---

SECTION THREE

Equipment	17
-----------------	----

SECTION FOUR

Penalties	31
-----------------	----

SECTION FIVE

Officials	47
-----------------	----

SECTION SIX

Playing Rules	55
---------------------	----

APPENDICES

I Summary of Penalties	87
II Summary of Face-Off Locations	95
III Official Signals	99
IV Official Rink Diagrams	111
V Glossary	117

INDEX

Rule References	125
-----------------------	-----

PREFACE

Points of Emphasis
Standard of Play and Rule Emphasis
Philosophy of Youth Hockey
Codes of Conduct
Zero Tolerance Policy
Note to Reader



Points of Emphasis 2013 Through 2017 Seasons

The goal of USA Hockey is to promote a safe and positive playing environment for all participants while continuing to focus on skill development and enjoyment of the sport. All officials, coaches, players, parents, spectators and volunteers are encouraged to observe these “Points of Emphasis” when participating in the sport of ice hockey.

Fair Play and Respect

Fair play and respect are the backbone of any successful amateur sports program. In order for a positive environment to be created, it is imperative that all participants and spectators have respect for all players, coaches, officials, administrators, spectators and the sport of hockey. Hockey is a game demanding high levels of concentration and skill. Taunting or unsportsmanlike conduct directed at opponents or officials will not be tolerated.

Intimidation tactics have no place in ice hockey. These tactics include any contact to the head of the opponent, checking from behind and late avoidable body checks to an opponent who is no longer in possession and control of the puck. Officials are instructed to enforce these rules to a high standard and assess the appropriate penalty when these actions occur. In addition, officials are expected to strictly enforce any avoidable contact occurring after the whistle – including during scrum situations around the goal.

In **Body Contact** categories, legal body contact shall be allowed and players allowed to compete using proper body position skills. However, any deliberate body checks shall be penalized accordingly. If a body check is delivered for the purpose of intimidation, a major penalty should be assessed to the offending player.

In **Body Checking** categories, the purpose of the check shall be to separate the opponent from the puck and officials should strictly penalize any illegal actions such as boarding, charging and a late avoidable body check to a player who is no longer in possession and control of the puck.

Players are encouraged to develop a deep sense of respect for all (opponents and officials) while endeavoring to enjoy the sport and improve their playing ability. Each player is expected to use proper skill and technique when engaging in any type of body contact.

Coaches are responsible for instructing their players to play the sport in a safe and sportsmanlike manner. To that end, coaches are directed to teach only those skills necessary to allow for proper and legal body contact.

Officials should be diligent and confident when officiating the sport. Each official should enforce all playing rules fairly and respectfully with the safety of the players and the best interest of the game in mind. Players must be held accountable for dangerous and illegal actions with the proper enforcement of the rules at all times.

Spectators are encouraged to support their teams while showing respect for all players, coaches, officials and other spectators.

Standard of Play and Rule Emphasis

USA Hockey will continue to observe the Standard of Play and Rule Emphasis for restraining fouls adopted in June 2006. The goal is to reduce restraining infractions in the game, allowing the skill levels of the participants to determine the outcome of a game and to increase participant enjoyment.

USA Hockey will also continue to emphasize the Body Checking Standard of Play and Rule Emphasis adopted in 2011 as part of its effort to create a safe environment for all participants. The goal is to enhance player skill development by eliminating intimidating infractions designed to punish the opponent. Proper enforcement of this standard will improve the proper skill of legal body checking or legal body contact at all levels of play.

Conclusion

Hockey should be enjoyed by all participants. To that end, all participants and spectators should observe a level of personal behavior that demonstrates respect for all. USA Hockey will continue to increase awareness among all officials and coaches with regard to these Points of Emphasis and the Standard of Play and Rule Enforcement.

Standard of Play and Rule Emphasis – Body Checking

Through the standard of rules enforcement, our game will continue to allow the opportunity for improved skill development and a more positive hockey environment for all participants. This initiative will result in greater emphasis on skating, puck possession and the proper use of the body to establish position and legally gain a competitive advantage.

The goal of the enforcement standard is to create an environment that enhances player skill development by reducing intimidating infractions designed to punish the opponent. This standard is designed to improve the proper skill of legal body checking or contact at all levels of play and will not remove the physical component from the game. A hard body check or using body contact/position (Body Contact categories) to gain a competitive advantage over the opponent should not be penalized as long as it is performed within the rules. The focus of the body check should be to separate the opponent from the puck.

The principles of this enforcement standard include the following:

- The purpose of a body check is to separate the opponent from the puck.
- Only the trunk (hips to shoulders) of the body shall be used to deliver a body check.
- The check must be delivered to the trunk (hips to shoulders) and directly from in front or the side of the opponent.
- Players who use their physical skills and/or anticipation and have a positional advantage shall not lose that advantage provided they use their body to check the opponent within the rules.
- Players will be held accountable for acts of an intimidating or dangerous nature.

Enforcement Standard – These penalties are to be called with very strict enforcement.

BODY CHECKING (Body Contact Categories)

A player cannot deliver a body check to any player while participating in a Body Contact category. Examples include:

- Makes deliberate physical contact with an opponent with no effort to legally play the puck.

- Uses overt hip, shoulder or arm contact with the opponent to physically force them off the puck.
- Physically impedes the progress of the opponent with hips, shoulders or torso without establishing legal body contact and having no intent of playing the puck.

BOARDING

A player cannot commit any infraction, including body checking, for the purpose of intimidation or punishment that causes their opponent to go violently or excessively into the boards. Examples include:

- Accelerating through the check to a player who is in a vulnerable position off of the boards that causes them to go violently into the boards.
- Driving an opponent excessively into the boards with no focus on or intent to play the puck.
- Any other infraction (tripping, cross-checking, charging etc.) that causes the opponent to go violently and excessively into the boards.

CHARGING

A player cannot take more than two fast strides or travel an excessive distance to accelerate through a body check for the purpose of punishing the opponent. Examples include:

- Running or jumping into the opponent to deliver a check.
- Accelerating through a check for the purpose of punishing the opponent.
- Skating a great distance for the purpose of delivering a check with excessive force.

CHECKING FROM BEHIND

A player cannot deliver a body check to an opponent directly from behind, or diagonally from behind. The onus is on the player delivering the check to not hit from behind. Examples include:

- Body checking or pushing an opponent from behind directly into the boards or goal frame or in open ice.

HEAD CONTACT

A player cannot contact an opponent in the head, face or neck, including with the stick or any part of the players body or equipment. The onus is on the player delivering the check, regardless as to size differential, to not make contact in the head/neck area of the opponent. Examples include:

- A body check delivered with any part of the body that makes direct contact with the head or neck area.
- The use of the forearm or hands to deliver a check to the head or neck area of the opponent.

ROUGHING

A player cannot use the hands, stick or extension of the arms to body check an opponent or deliver an avoidable body check to a player who is not in possession and control of the puck. Examples include:

- Intentionally playing the body of an opponent who does not have possession and control of the puck.
- Delivering an avoidable check to a player who has already relinquished control of the puck by a pass or shot. This is oftentimes referred to as “finishing” the check.
- Any avoidable contact after the whistle shall be penalized strictly, including scrum situations around the goal or along the boards. Officials are instructed to assess an additional penalty to those players acting as the aggressor or who instigates any contact after the whistle.

SUMMARY

All USA Hockey members must demonstrate awareness and support for the application, spirit and the respect of the rules in order for continued improvement in the game of hockey. At the same time, it is important to remember that:

- A player is entitled to use proper body position and body contact in all age classifications in order to gain a competitive advantage.
- Players are allowed to compete for body position using their strength and balance in front of the goal or along the boards.
- In **Body Checking categories**, the focus of the body check must be to separate the opponent from the puck.

Standard of Play and Rule Emphasis – Restraining Fouls

Through the standard of rules enforcement, our game will continue to allow the opportunity for improved skill development and a more positive hockey environment for all participants.

The goal of the enforcement standard is to reduce restraining infractions in the game and not to remove legal body checking or body contact. A hard body check or using body contact/position (Body Contact categories) to gain a competitive advantage over the opponent should not be penalized as long as it is performed within the rules.

The principles of the continued enforcement standard include the following:

- The use of the stick will be limited to only playing the puck.
- The stick will not be allowed to in any way impede a player's progress.
- The use of a free hand/arm will not be allowed to grab or impede a player's progress.
- Players who use their physical skills and/or anticipation and have a positional advantage shall not lose that advantage as a result of illegal acts by the opponent.
- Players will be held accountable for acts of an intimidating or dangerous nature.

Enforcement Standard – These penalties are to be called with very strict enforcement.

HOOKING

A player cannot use his/her stick against an opponent's body (puck carrier or non-puck carrier) to gain a positional advantage.

Examples include:

- Tugs or pulls on the body, arms or hands of the opponent which allows for the space between the players to diminish.
- Placing the stick in front of the opponent's body and locking on – impeding the opponent's progress or causing a loss of balance.
- Stick on the hand/arm that takes away the ability for the opponent to pass or shoot the puck with a normal amount of force.

TRIPPING

A player cannot use his/her stick on the legs or feet of an opponent in a manner that would cause a loss of balance or for them to trip or fall. Examples include:

- Placing the stick in front of the opponent's legs for the purpose of impeding progress, even if on the ice, with no effort to legally play the puck.
- Placing the stick between the legs of the opponent (can opener/corkscrew) that causes a loss of balance or impedes the progress of the opponent.

HOLDING

A player cannot wrap his/her arms around an opponent or use a free hand to clutch, grab or hold the stick, jersey or body on the opponent in a manner that impedes their progress. Examples include:

- Wrapping one or both arms around the opponent along the boards in a manner that pins them against the boards and prevents them from playing the puck or skating.
- Grabbing the opponent's body, stick or sweater with one or both hands.
- Using a free arm/hand to restrain or impede the opponent's progress.

INTERFERENCE

A player cannot use his/her body ("pick" or "block") to impede the progress of an opponent with no effort to play the puck, maintain normal foot speed or established skating lane. Examples include:

- Intentionally playing the body of an opponent who does not have possession or possession and control of the puck.
- Using the body to establish a "pick" or "block" that prevents an opponent from being able to chase a puck carrier.
- Reducing foot speed or changing an established skating lane for the purpose of impeding an opponent from being able to chase a puck carrier.

SLASHING

The use of the stick will be limited to only playing the puck. Any stick contact, as a result of a slashing motion, to the hands/ arms or body of the opponent will be strictly penalized. In addition, hard slashes to the upper portion of the stick (just below the hands) of an

opponent, with no attempt to legally play the puck, shall also be penalized.

CONCLUSION

All USA Hockey members must demonstrate awareness and support for the application, spirit and the respect of the rules in order for continued improvement in the game of hockey. At the same time, it is important to remember that:

- Players are entitled to the ice they occupy as long as they are able to maintain their own foot speed and body position between opponent and puck.
- Players are allowed to compete for body position using their strength and balance in front of the goal or along the boards.

Coaches are expected to teach proper skills and hold their players accountable for illegal and dangerous actions, regardless as to whether they are properly penalized, or not.

Parents are expected to support the decisions of the officials and support the coaches in teaching the proper skills in a safe and positive environment.

Officials shall enforce a strict penalty standard according to the guidelines that have been established.

Players are expected to compete within the playing rules.

Administrators are expected to hold players, coaches, officials and parents accountable for their actions in an effort to promote a safe and positive environment for all participants.

All members of USA Hockey share an equal responsibility to ensure the integrity of the game is upheld. The onus to incorporate change is not only on the officials, but also on administrators, coaches, parents and players, as well.

Philosophy of Youth/Girls' Hockey

The USA Hockey mission statement for its Youth and Girls' Programs is as follows: To provide an innovative grassroots foundation for the growth and development of USA Hockey, designing programs aimed at increased participation, improved skills and a responsible environment for the conduct of youth hockey.

The American Development Model (ADM), which includes programs at all levels, is the basis for youth hockey in the United States. It provides:

- A safe and healthy environment for all.
- An opportunity for all new players who wish to play hockey.
- Fair and equal opportunity for all to participate in our sport.
- An opportunity to learn the basic skills without an over-emphasis on winning.
- A philosophy which attempts to reduce the number who become disenchanting.
- An opportunity for those who wish to advance in a more competitive environment to do so.
- Qualified adult leadership.

USA Hockey recommends:

- Scoring records should be de-emphasized at the age of 11 & under.
- Awards should be inexpensive and based on significant achievement. The most gratifying award any player can receive is the joy that comes from skill development that contributes to team success.
- The recruitment of players on a widespread geographic basis for the establishment of youth division "travel teams" (**beginning at 14U**) may be pursued under the guidelines established by USA Hockey.
- It is recommended that adult volunteers place a primary emphasis on the formal education of players and a de-emphasis on excessive competition and a win-at-all-costs attitude in the youth age classifications.
- Sportsmanship at all times should be emphasized.

Codes of Conduct

Administrator's Code of Conduct

- Follow the rules and regulations of USA Hockey and your association to ensure that the association's philosophy and objectives are enhanced.
- Support programs that train and educate players, coaches, parents, officials and volunteers.
- Promote and publicize your programs; seek out financial support when possible.
- Communicate with parents by holding parent/player orientation meetings as well as by being available to answer questions and address problems throughout the season.
- Work to provide programs that encompass fairness to the participants and promote fair play and sportsmanship.
- Recruit volunteers, including coaches, who demonstrate qualities conducive to being role models to the youth in our sport.
- Encourage coaches and officials to attend USA Hockey clinics and advise your board members of the necessity for their training sessions.
- Make every possible attempt to provide everyone, at all skill levels, with a place to play.
- Read and be familiar with the contents of the *USA Hockey Annual Guide* and USA Hockey's official playing rules.
- Develop other administrators to advance to positions in your association, perhaps even your own.

Coach's Code of Conduct

- Winning is a consideration, but not the only one, nor the most important one. Care more about the child than winning the game. Remember, players are involved in hockey for fun and enjoyment.
- Be a positive role model to your players. Display emotional maturity and be alert to the physical safety of players.
- Be generous with your praise when it is deserved; be consistent and honest; be fair and just; do not criticize players publicly; learn to be a more effective communicator and coach; don't yell at players.
- Adjust to personal needs and problems of players; be a good listener; never verbally or physically abuse a player or official; give all players the opportunity to improve their skills, gain confidence and develop self-esteem; teach players the basics.

- Organize practices that are fun and challenging for your players. Familiarize yourself with the rules, techniques and strategies of hockey; encourage all your players to be team players.
- Maintain an open line of communication with your players' parents. Explain the goals and objectives of your association.
- Be concerned with the overall development of your players. Stress good health habits and clean living.
- To play the game is great, to love the game is greater.

On-Ice Official's Code of Conduct

- Act in a professional and businesslike manner at all times and take your role seriously.
- Strive to provide a safe and sportsmanlike environment in which players can properly display their hockey skills.
- Know all playing rules, their interpretations and their proper application.
- Remember that officials are teachers. Set a good example.
- Make your calls with quiet confidence; never with arrogance.
- Manage and help to control games in cooperation with the coaches to provide a positive and safe experience for all participants.
- Violence must never be tolerated.
- Be fair and impartial at all times.
- Answer all reasonable questions and requests.
- Adopt a "zero tolerance" attitude toward verbal or physical abuse.
- Never use foul or vulgar language when speaking with a player, coach or parent.
- Use honesty and integrity when answering questions.
- Admit your mistakes when you make them.
- Never openly criticize a coach, player or fellow official.
- Keep your emotions under control.
- Use only USA Hockey-approved officiating techniques and policies.
- Maintain your health through a physical conditioning program.
- Dedicate yourself to personal improvement and maintenance of officiating skills.
- Respect your supervisor and his/her critique of your performance.

Parent's Code of Conduct

- Do not force your children to participate in sports, but support their desires to play their chosen sports. Children are involved in organized sports for their enjoyment. Make it fun.
- Encourage your child to play by the rules. Remember, children learn best by example, so applaud the good plays of both teams.
- Do not embarrass your child by yelling at players, coaches or officials. By showing a positive attitude toward the game and all of its participants, your child will benefit.
- Emphasize skill development and practices and how they benefit your young athlete. De-emphasize games and competition in the lower age groups.
- Know and study the rules of the game and support the officials on and off the ice. This approach will help in the development and support of the game. Any criticism of the officials only hurts the game.
- Applaud a good effort in both victory and defeat, and enforce the positive points of the game. Never yell or physically abuse your child after a game or practice – it is destructive. Work toward removing the physical and verbal abuse in youth sports.
- Recognize the importance of volunteer coaches. They are important to the development of your child and the sport. Communicate with them and support them.
- If you enjoy the game, learn all you can about hockey – and volunteer.

Player's Code of Conduct

- Play for fun.
- Work hard to improve your skills.
- Be a team player – get along with your teammates.
- Learn teamwork, sportsmanship and discipline.
- Be on time.
- Learn the rules and play by them. Always be a good sport.
- Respect your coach, your teammates, your parents, opponents and officials.
- Never argue with an official's decision.

Spectator's Code of Conduct

- Display good sportsmanship. Always respect players, coaches and officials.
- Act appropriately; do not taunt or disturb other fans; enjoy the game together.
- Cheer good plays of all participants; avoid booing opponents.
- Cheer in a positive manner and encourage fair play; profanity and objectionable cheers or gestures are offensive.
- Help provide a safe and fun environment; throwing any items on the ice surface can cause injury to players and officials.
- Do not lean over or pound on the glass; the glass surrounding the ice surface is part of the playing area.
- Support the referees and coaches by trusting their judgment and integrity.
- Be responsible for your own safety – be alert to prevent accidents from flying pucks and other avoidable situations.
- Respect locker rooms as private areas for players, coaches and officials.
- Be supportive after the game – win or lose. Recognize good effort, teamwork and sportsmanship.

Zero Tolerance Policy

In an effort to make ice hockey a more desirable and rewarding experience for all participants, USA Hockey instituted a zero tolerance policy beginning with the 1992-93 season. This policy requires all players, coaches, officials, team officials and administrators and parents/spectators to maintain a sportsmanlike and educational atmosphere before, during and after all USA Hockey-sanctioned games.

Thus, the following points of emphasis must be implemented by all referees and linesmen:

Players

A minor penalty for unsportsmanlike conduct (zero tolerance) shall be assessed whenever a player:

- 1) Openly disputes or argues any decision by an official.
- 2) Uses obscene or vulgar language at any time, including any swearing, even if it is not directed at a particular person.
- 3) Visually demonstrates any sign of dissatisfaction with an official's decision. Any time that a player persists in any of these actions, they shall be assessed a misconduct penalty. A game misconduct shall result if the player continues such action.

Coaches

A minor penalty for unsportsmanlike conduct (zero tolerance) shall be assessed whenever a coach:

- 1) Openly disputes or argues any decision by an official.
- 2) Uses obscene or vulgar language in a boisterous manner to anyone at any time.
- 3) Visually displays any sign of dissatisfaction with an official's decision including standing on the boards or standing in the bench doorway with the intent of inciting the officials, players or spectators.

Any time that a coach persists in any of these actions, he/she shall be assessed a game misconduct penalty.

Officials

Officials are required to conduct themselves in a businesslike, sportsmanlike, impartial and constructive manner at all times. The actions of an official must be above reproach. Actions such as “baiting” or inciting players or coaches are strictly prohibited.

Officials are ambassadors of the game and must always conduct themselves with this responsibility in mind.

Parents/Spectators

The game will be stopped by game officials when parents/spectators displaying inappropriate and disruptive behavior interfere with other spectators or the game. The game officials will identify violators to the coaches for the purpose of removing parents/spectators from the spectator’s viewing and game area. Once removed, play will resume. Lost time will not be replaced and violators may be subject to further disciplinary action by the local governing body. This inappropriate and disruptive behavior shall include:

- 1) Use of obscene or vulgar language in a boisterous manner to anyone at any time.
- 2) Taunting of players, coaches, officials or other spectators by means of baiting, ridiculing, threat of physical violence or physical violence.
- 3) Throwing of any object in the spectators viewing area, players bench, penalty box or on ice surface, directed in any manner as to create a safety hazard.

Note to Reader

Please note that the shaded text within this edition of the Official Rules signifies an adjustment within that particular text. Additionally, the words “he,” “him” and “his” are used to include both male and female participants.

SECTION ONE
THE RINK



Rule 101 Rink

(Note) This section of the rulebook refers to guidelines for an ice hockey rink as recommended by USA Hockey. For more precise dimensions and facility requirements, please refer to the Serving The American Rinks (STAR) Facility Guide or see Appendix IV – Official Rink Diagrams.

- (a) The game of “Ice Hockey” shall be played on an ice surface known as the “RINK.”

Rule 102 Dimensions of Rink

- (a) As nearly as possible, the dimensions of the rink shall be 200 feet long and 85-100 feet wide. The corners shall be uniformly rounded in the arc of a circle with a recommended radius of 28 feet.

For regional playoffs and national championships the ice surface dimensions shall be not less than 185 feet by 85 feet.

- (b) The rink shall be surrounded by a framed enclosure, known as the “BOARDS.” The boards shall be constructed in such a manner that the surface facing the ice shall be smooth and free of any obstruction. The portion of the boards that contacts the ice surface shall be known as the “KICKPLATE.”

All doors giving access to the field of play must swing away from the ice surface.

- (c) It is recommended that the entire rink, including players and penalty benches, be enclosed by a clear and colorless material, known as “SHIELDING.” The shielding is designed to separate the field of play from spectators.

It is strongly recommended that protective netting be used above the shielding, surrounding the entire field of play.

Rule 103 Division of Ice Surface

- (a) A "GOAL LINE," shall be placed eleven feet from the inside facing of the end boards. The goal line shall extend across the width of the ice and vertically up the entire height of the side boards.

A cross-ice goal line may be placed nine feet three inches from all side boards in each of the three zones for cross-ice hockey play. The line shall measure three feet on both sides of the center point of each zone.

All goal lines shall be red in color and two inches wide.

- (b) In front of each goal, a "GOAL CREASE" area shall be marked by a red line and shall be laid out as follows: A semi-circle line six feet (6') in radius and two inches in width shall be marked using the center of the goal line as the center point.

In addition, four feet (4') from the center of the goal crease, a two inch (2") red line shall be marked that extends to the edge of the semicircle line. These lines shall be at right angles to the goal line and the area inside these lines shall be marked light blue in color. The area outside of these lines and the space enclosed by the goal line and the base of the goal frame, shall be white in color.

The goal crease area shall include all the space outlined by the semi-circular crease lines (including crease lines) and extending vertically to the level of the top of the goal frame.

An optional cross-ice goal crease may be marked in front of each cross-ice goal line. A semi-circle three feet in radius from the center point of the goal line shall be marked with a red line.

- (c) The ice surface between the two goal lines shall be divided into three parts by lines, known as the "BLUE LINES," 12 inches in width and blue in color. These lines shall measure 64 feet from the goal line. The blue lines shall extend completely across the width of the rink, parallel with the goal line and continued vertically up the entire height of the side boards.

These three parts shall be identified as the “DEFENDING ZONE” (the area in which the goal each team defends is placed), the “NEUTRAL ZONE” (the center area between the blue lines) and the “ATTACKING ZONE” (the area farthest from the defending goal). The blue line shall be considered part of the zone that the puck is in.

- (d) The ice surface shall be divided exactly in half by a line, known as the “CENTER LINE,” 12 inches in width and red in color, extending completely across the width of the rink, parallel with the goal lines and continued vertically up the entire height of the side boards. The outer edges of the center line shall be two inches (2”) in width and uninterrupted across the width of the rink.

Rule 104 Face-Off Spots and Face-Off Circles

- (a) A circular “FACE-OFF SPOT,” blue in color and 12 inches in diameter, shall be marked exactly at the center of the rink. Additionally, a “FACE-OFF CIRCLE” shall be marked using a line 2 inches (2”) in width and blue in color.
- (b) Four (4) face-off spots, red in color, two feet in diameter shall be marked on the ice in the Neutral Zone.
In both End Zones and on both sides of each goal, two (2) face-off spots, red in color, two feet in diameter shall be marked.
- (c) In each End Zone, two (2) face-off circles shall be marked. The outside of each face-off circle shall contain “HASH MARKS” that are parallel to the goal line.
Each face-off circle shall contain “L” shaped markings, known as “PLAYER RESTRAINT LINES.”
All lines shall be 2 inches in width and red in color.
- (d) A semicircle shall be known as the “REFEREE’S CREASE” and shall be marked using a center point immediately in front of the Scorekeeper. The line shall be 2 inches in width and red in color.

Rule 105 Goals

- (a) The goal frame should be of approved design and material and shall extend four feet high from the ice surface and six feet wide when measured from the inside of the goal frame. A net of approved design and material should be attached to each goal frame in a manner in which to prevent the puck from going completely through the frame. The goal posts and cross bar shall be painted red in color while all other surfaces shall be painted white.
- (b) A regulation goal frame shall be placed at the center of the goal line. The goal frame shall be set in a manner to remain stationary during the progress of the game. If applicable, the goal posts shall be anchored in a manner that would permit the goal posts to become dislodged when hit by a reasonable degree of force created by the player when sliding or being checked into the posts.

Rule 106 Players' Bench

- (a) Each rink shall provide players' benches with benches or chairs and doors that are uniform for both teams. Each players' bench shall be separated by a reasonable distance or divider. All doors for the players' benches shall swing away from the ice surface.

Rule 107 Penalty Bench

- (a) Each rink shall provide penalty benches with benches or chairs and doors that are uniform for both teams. Each penalty bench shall be separated by a reasonable distance or divider. All doors for the penalty benches shall swing away from the ice surface.

Rule 108 Signal and Timing Devices

- (a) Each rink shall provide a siren or other suitable sound device for the use of Timekeepers.
- (b) Each rink shall provide a timing device for the purpose of keeping all parties accurately informed as to the time remaining in each period and/or to be served for each penalty.
- (c) For games where goal judges are used, a signaling device will be placed behind each goal.
- (d) Where automatic lights are available, a red light will indicate a goal has been scored and a green light will signal the end of a period.
- (e) It is the responsibility of the on-ice officials to determine if a goal has been scored at the end of a period regardless of the use of signaling devices.

SECTION TWO
TEAMS



Rule 201 Composition of Teams

- (a) A team must start a game with a minimum of six players. Any time that a team has been reduced to less than four players, the game shall be declared a forfeit.
A maximum of 20 players, in which not more than 18 are skaters, shall be permitted to play in the game.
- (b) Each team shall designate on the scoresheet a Head Coach prior to the start of the game. The Head Coach shall be in control of and responsible for the actions of all team personnel, including players.
A team may have up to four Team Officials on the players' bench. Only players in uniform and properly rostered Team Officials may occupy the players' bench.
If at any time during the game, through penalties, illness, or any other reasons, there are no Team Officials on the players' bench to be in control of and responsible for the team, the game shall continue provided there is adult supervision on the bench. If no adult supervision is available, the referee shall suspend the game and submit a report to the proper authorities.
- (c) Any Team Official serving a suspension penalty may not sit near the bench of his team, nor in any way attempt to direct the play of his team.

Rule 202 Captain of Team

- (a) Prior to the start of the game, each team shall designate one Captain and not more than two Alternates on the scoresheet. Only one of these designated players shall have the privilege of discussing with the Referee any questions relating to interpretation of rules that may arise during the progress of a game. No goalkeepers shall be entitled to exercise the privileges of Captain.
Each designated player should wear the letter "C" or "A," approximately three inches in height and in contrasting color, on the front of the sweater.
- (b) Any Captain who comes off the bench and protests or interferes with the Officials for any purpose shall be assessed a minor penalty for unsportsmanlike conduct.

Rule 203 **Players in Uniform**

- (a) Prior to the start of each game the Manager or Coach of each team shall designate on the scoresheet the players and goalkeepers who shall be eligible to play in the game.
Once the game has started, an eligible player or goalkeeper may be added to the scoresheet during a stoppage of play provided no players are deleted from the game roster and maximum roster size has not been exceeded. For each player added however, a bench minor penalty for illegal substitution shall be assessed.
- (b) Each player and goalkeeper on the game roster shall wear a visible individually identifying number (only whole numbers 0-99 inclusive) that is proportionate to the size of the participants.
All players of each team shall be dressed uniformly.
- (c) It is recommended that each team shall have a substitute goalkeeper who shall be fully dressed and equipped to play. Each team shall be allowed one goalkeeper on the ice at any time during the game.
- (d) Except when all goalkeepers are incapacitated, no player on the game roster shall be permitted to wear the equipment of the goalkeeper. If a team has no designated goalkeeper who is able to continue, the team must immediately appoint a temporary goalkeeper (see Glossary) or place an additional skater on the ice who shall not have goalkeeper's privileges.

Rule 204 **Playing Lineup**

- (a) Upon the Referee's signal prior to the start of a period and following any stoppage of play, the visiting team shall have five seconds to place a lineup on the ice. The home team is then provided 5 seconds to place their lineup on the ice. Once the substitutions have occurred, no additional changes may be made until play has resumed, unless a penalty has been imposed.
If there is any undue delay by either team in placing their lineup on the ice, the Referee shall warn the offending team. Any subsequent delay by the same team will result in a minor penalty for delay of game. (Also see Rule 633, Refusing to Start Play.)

- (b) When the substitute goalkeeper enters the game he will take his position without delay and no warm-up shall be permitted, except when either team uses its Time-out under Rule 636(f). The original goalkeeper may not return to play until the next stoppage of play. For a violation, the offending team shall be assessed a bench minor penalty for illegal substitution.

Rule 205 Change of Players

- (a) Players may be changed at any time from the players' bench, provided that the player or players leaving the ice shall always be at the players' bench and out of the play before any change is made. If either the player entering or leaving the game deliberately plays the puck in any manner or makes physical contact with an opposing player while the retiring player is actually on the ice, then a bench minor penalty for "too many players on the ice" shall be assessed.

If, in the course of a substitution, either the player entering the play or the player retiring is struck by the puck accidentally, the play will not be stopped and no penalty shall be called.

- (b) A goalkeeper may be changed for another player (who shall not have goalkeeper privileges) at any time provided the goalkeeper is at the bench and out of play prior to the substitute entering the ice. If the substitution is made prematurely, there shall be no time penalty assessed. However, the resulting face-off will take place at the center face-off spot unless play was stopped with the play in the offending team's defending half of the ice, in which case the face-off will take place where play was stopped, unless otherwise specified in the rules.

When a goalkeeper leaves his goal area and proceeds to his players' bench for the purpose of substituting another player, the rear Linesman shall be responsible to see that the substitution made is legal. If the substitution is made prematurely, the Linesman shall stop the play immediately unless the non-offending team has possession of the puck, in which event the stoppage will be delayed until a change in possession take place.

- (c) A goalkeeper may be substituted for by another goalkeeper during play with full goalkeeper privileges.

During a stoppage of play a goalkeeper may not go to his players' bench without the permission of the Referee unless he is substituted for by another player or goalkeeper.

When a substitution for the goalkeeper has been made under this rule, the goalkeeper shall not resume his position until the next stoppage of play, except that he shall be permitted immediate re-entry into the game when any penalty is imposed.

For a violation of this rule a bench minor penalty for illegal substitution shall be assessed.

- (d) A player serving a penalty on the penalty bench, whose penalty has expired, must proceed by way of the ice and be at his players' bench before any substitution can be made.
- (e) If there are less than two minutes remaining in regulation time or anytime during overtime and a minor or bench minor penalty is imposed for deliberate illegal substitution, such as too many players on the ice or leaving the penalty bench too soon, a penalty shot/optional minor penalty shall be assessed against the offending team.

(Note) The intent of this rule is to award a penalty shot/optional minor only when the extra player(s) are "deliberately" put on the ice. When a substitution error is made and there are too many players on the ice, the normal bench minor penalty shall be assessed regardless of the time remaining in the game.

Rule 206 Injured Players

- (a) When a player is injured or compelled to leave the ice during a game, he may retire from the game and be replaced by a substitute under the player substitution rules.

When a player is injured and is unable to continue play or go to his bench, play shall be stopped immediately unless the opposing team is in possession of the puck, in which case play shall not be stopped until a change of possession has occurred.

In the case where it is obvious that a player has sustained a serious injury, the Referee and/or Linesman may stop the play immediately.

A player other than a goalkeeper, whose injury appears serious enough to warrant the stoppage of play, may not participate further in the game until the completion of the ensuing face-off.

- (b) If a goalkeeper sustains an injury or becomes ill he must be ready to resume play immediately or be replaced by a substitute goalkeeper. No additional time shall be allowed by the Referee for the purpose of enabling the injured or ill goalkeeper to resume his position. (See also Rule 205(c).)

The substitute goalkeeper shall be subject to the rules governing goalkeepers and shall be entitled to the same privileges.

- (c) A player or goalkeeper who is obviously bleeding shall cause an immediate stoppage of play. The bleeding player shall be ruled off the ice and shall not be allowed to return to play until the bleeding has been stopped and the cut or abrasion covered. It is required that any affected equipment/uniform be properly decontaminated or exchanged.

- (d) If a penalized player has been injured he may proceed to the dressing room without the necessity of taking a seat on the penalty bench.

If the injured player receives a minor penalty, the penalized team shall place a substitute on the penalty bench immediately. If the injured player receives a major penalty, Rule 403(d) would apply and no replacement for the penalized player shall be permitted to enter the game except from the penalty bench.

The penalized player who has been injured and been replaced on the penalty bench shall not be eligible to play in the game until his penalty has expired. Should the penalized player return to the game before his penalty has expired, he shall replace the substitute player on the penalty bench during a stoppage of play.

For a violation of this rule a bench minor penalty for illegal substitution shall be imposed.

(Note) No substitution on the penalty bench is required under this rule for any player(s) who have been immediately substituted on the ice under Rule 402(f)-coincidental minor penalties and/or Rule 403(c)-coincidental major penalties.

SECTION THREE
EQUIPMENT



Rule 301 Sticks

- (a) The sticks shall be made of wood or other material approved by the Rules Committee, and must not have any projections. All edges of the blade shall be beveled. The end of a hollow shaft must be fully covered. Adhesive tape of any color may be wrapped around the stick at any place for the purpose of reinforcement or to improve control of the puck.
- (b) No stick shall exceed 63 inches in length from the heel to the end of the shaft. The widened portion of the goalkeeper's stick extending up the shaft from the blade shall not extend more than 26 inches from the heel and shall not exceed $3\frac{1}{2}$ inches in width.

The blade of the player's stick shall not exceed $12\frac{1}{2}$ inches in length and 3 inches in width. The width of the blade shall be a minimum of 2 inches at any point measured along the blade.

The blade of the goalkeeper's stick shall not exceed $15\frac{1}{2}$ inches in width from the heel to the end. The blade of the goalkeeper's stick shall be between 2 inches and $3\frac{1}{2}$ inches wide except at the heel where the maximum width shall be $4\frac{1}{2}$ inches.

The curvature of the blade, measured in such a way that a straight line drawn from the heel to the base of the toe shall not exceed $\frac{3}{4}$ inch at the point of maximum curvature.

- (c) A minor penalty for an equipment violation shall be assessed to any player or goalkeeper who uses a stick not conforming to the provisions of this rule.

(Note) When a request for measurement is made by the Captain of a team against the dimensions of any stick, the Referee shall make the necessary measurement immediately.

If the complaint is not sustained, a bench minor penalty for delay of game shall be assessed to the team requesting the measurement.

If a goal is scored with an illegal stick, the proper penalty shall be assessed and the goal shall be allowed.

- (d) A minor penalty for unsportsmanlike conduct plus a misconduct penalty shall be assessed to any player who

refuses to surrender his stick for measurement when requested to do so by the Referee.

- (e) A minor penalty for an equipment violation shall be assessed to a player or goalkeeper who participates in the play while he is in possession of more than one stick, except that no penalty shall be assessed to a player who is accidentally struck by the puck while he is carrying a replacement stick to a teammate.

Rule 302 Skates

- (a) All participants must wear hockey skates of a design approved by the Rules Committee. The use of speed skates, figure skates or any skate so designed that it may cause injury is prohibited.

When the Referee becomes aware that any player is wearing skates that are not designed for hockey and are deemed to be unsafe, he shall order that player off the ice immediately and such player shall not be permitted to participate further in the game until the skates are replaced.

- (b) No additional equipment or contrivance shall be attached to the skates of any player or goalkeeper.

Rule 303 Goalkeeper's Equipment

- (a) With the exception of skates and stick, all the equipment worn by the goalkeeper must be constructed solely for the purpose of protecting the head or body, and he must not wear any garment or use any contrivance that would give him undue assistance in keeping goal.
- (b) It is compulsory for all goalkeepers to wear helmets and full facemasks. Hanging throat/neck laceration protectors are recommended. No form fitted facemasks shall be permitted.
- (c) **Gloves** – the dimensions of the goalkeeper's blocker glove shall not exceed 8 inches in width or 15 inches in length.

The cuff of the catching glove shall not exceed 8 inches in width. The circumference of the glove shall not exceed 45 inches. The catching portion of the glove (measured from the heel – the point where the cuff meets the glove – to the top of the "T" trap and following the contour of the glove) must not exceed 18 inches.

(Note) Any bar or attachment (cheater bar) between the cuff and the thumb shall only extend from the cuff to the thumb in a straight line. Any additional lacing, webbing or other material attached to the glove shall deem the equipment illegal.

- (d) **Leg Pads** – The leg guards worn by goalkeepers shall not exceed 11 inches in extreme width and 38 inches in length. The boot channel of the goalkeeper pad must be flat or concave in appearance with no additional attachments such as a puck foil. The boot is the bottom of the pad that sits over the top of the skate. Calf protectors must follow the contour of the calf and ankle and can have a thickness of no greater than 1 ½ inches.

The knee strap pad is not to exceed 1 ½ inches in thickness and must be fastened to the inner risers and follow the contour of the inner knee.

All thigh pads must follow the contour of the leg, or placed under the pant, and the maximum width of the thigh pad across the front of the leg is 10 inches.

- (e) **Pants** – No internal, external or cheater padding is permitted on the pant leg or waist beyond what is required to provide protection (no outside or inside ridges). Abdominal aprons extending down the front of the thighs on the outside of the pants are prohibited.
- (f) **Chest/Shoulder Protection** – No raised ridges are allowed on the front edges or sides of the chest pad, the inside or outside of the arms, or across the shoulders.

Layering at the elbow is permitted to add protection but not to add stopping area. This layering, both across the front and down the sides to protect the point of the elbow shall not exceed 7 inches.

Shoulder cap protectors must follow the contour of the shoulder cap without becoming a projection/extension beyond or above the shoulder or shoulder cap. This contoured padding must not be more than 1 inch in thickness beyond the top ridge of the shoulder and shoulder cap.

On each side, the shoulder clavicle protectors are not to exceed 7 inches in width and their maximum thickness is to be 1 inch. This protection is not to extend or project above or

beyond the shoulder or shoulder cap nor extend beyond the armpit. No insert is allowed between the shoulder clavicle protector and the chest pad that would elevate the shoulder clavicle protector.

If when the goalkeeper assumes the normal crouch position, the shoulder and/or shoulder cap protection is pushed above the contour of the shoulder, the chest pad will be considered illegal.

- (g) A minor penalty for an equipment violation shall be assessed to any goalkeeper using illegal equipment in a game.

(Note) When a request for measurement is made by the Captain of a team against any dimensions of goalkeeper equipment, the Referee shall make the necessary measurement immediately.

If the challenge is not sustained, a bench minor penalty for delay of game shall be assessed to the team requesting the measurement.

Rule 304 Protective Equipment

(Note) Not all protective equipment is mandatory in all age classifications. However, if not mandated by rule, USA Hockey strongly recommends that all players and goalkeepers in all age classifications properly wear an internal mouthpiece, a HECC approved helmet and a HECC approved full facemask for all games and practices.

- (a) Each player is personally responsible to wear protective equipment for all games, warm-ups and practices. Such equipment should include gloves, shin pads, shoulder pads, elbow pads, hip pads or padded hockey pants, protective cup, tendon pads plus all head protective equipment as required by USA Hockey rules. It is recommended that all protective equipment be designed specifically for ice hockey.
- (b) All protective equipment, except gloves, padded hockey pants, helmet/facemask and goalkeeper's leg guards, must be worn under the uniform.

(Note) Players, including goalkeepers, violating this rule shall not be permitted to participate in the game until such equipment has been corrected or removed.

- (c) It is mandatory that all players (except Adults) wear a HECC approved helmet (including ear protection) with chin strap properly fastened.

(Note) HECC certification includes an expiration date on the sticker and a helmet that has an expiration date that has expired is no longer considered certified. The player may not wear a helmet that does not have a valid and current certification sticker.

Players in the Adult classification must wear a hockey helmet (including non-HECC approved) with chin strap properly fastened.

All players on the players' and the penalty bench must wear the protective helmet/facemask while in the bench area. For a violation of this rule, after a warning by the Referee, a misconduct penalty for an equipment violation shall be assessed to the offending player.

- (d) All players, including goalkeepers, in all age classifications below Adults, are required to wear a facemask certified by HECC, plus any chin protection that accompanies the facemask.

(Note) Any helmet or facemask that is altered except as permitted in Rule 304(c) shall be deemed to be illegal equipment and shall not be allowed to be used in a game. (This shall include helmets from which a part has been cut or removed, facemasks from which the chin-cup has been removed or any other such alterations from the original manufacturing specifications.)

- (e) In all classifications, excluding Adults, if a player's helmet/facemask comes off during play, the Referee or Linesman shall stop play immediately. The player shall be ruled off the ice and may not participate in the game until completion of the ensuing face-off.

A minor penalty for delay of game shall be assessed to a goalkeeper or player who causes a stoppage of play by deliberately removing his helmet/facemask during play.

In Adult classifications a player, excluding the goalkeeper, whose helmet/facemask has come off his head during play may not resume play until his helmet/facemask has been properly replaced. A player not conforming to this rule shall be assessed a minor penalty for an equipment violation.

In all classifications, if the goalkeeper's helmet/face mask comes off during play, the Referee or Linesman shall stop play immediately.

- (f) All players, including goalkeepers, in the 12 & under (Youth and Girls') through Youth 18 & under (including High School) and Girls' 19 & under age classifications are required to wear a colored (non-clear) internal mouthpiece that covers all the remaining teeth of one jaw, customarily the upper. It is strongly recommended, in all classifications, that all players wear a mouthpiece form fitted by a dentist.

For the first violation of this rule, the team shall be issued a warning. A misconduct penalty for an equipment violation shall be assessed to any player or goalkeeper of that team for a subsequent violation during that game.

- (g) All players must wear the required, or recommended, protective equipment in the manner for which it is designed.

For violation of this rule, following a team warning, a misconduct penalty for an equipment violation shall be imposed.

Rule 305 Dangerous Equipment

- (a) The use of pads or protectors made of metal, or of any other material likely to cause injury to a player, is prohibited. The wearing of casts or splints made of hard or unyielding materials is prohibited, even if padded, unless directed in writing by a licensed medical physician. Such casts or splints must be covered on all exterior surfaces with no less than $\frac{1}{2}$ inch thick, high-density, closed-cell polyurethane or an alternate material of the same minimum thickness and similar physical properties to protect an injury.
- (b) A glove from which all or part of the palm has been removed or cut to permit the use of the bare hand shall be considered illegal equipment. A misconduct penalty shall be assessed to any player wearing such a glove in play.
Any player wearing tape or any other material on his hands who cuts or injures an opponent during an altercation shall receive a match penalty under Rule 602.
- (c) Except for Adults, no player or goalkeeper shall be permitted on the ice while wearing jewelry unless it is completely covered by equipment or taped to the body.

Rule 306 Puck

- (a) The puck shall be made of vulcanized rubber or other approved material, one inch thick and three inches in diameter and shall weigh between 5 ½ ounces and 6 ounces and be black in color.
- (b) For the 8 & under (Youth) and for the 8 & under (Girls') and below age classifications, it is required that the puck weigh between 4 ounces and 4 ½ ounces and be blue in color.

It is strongly recommended that the lightweight blue puck be used in all 10 & under (Youth and Girls') age classifications.

Rule 307 Equipment Measurement

- (a) A request for measurement of any equipment covered by this section shall be limited to one request by each team during the course of any stoppage of play.
- (b) The Referee may, at his own discretion, measure any equipment, other than a stick, used for the first time in the game.
- (c) The Referee shall assess a bench minor penalty for delay of game against a team that requests any measurement (excluding mouthpiece) if the measurement verifies that the equipment is legal.

Rule 308 Electronic Devices

- (a) The use of one or two-way radios, lights or other electronic devices as a means for Team Officials or spectators to communicate with players or goalkeepers, during play, shall be prohibited.
- (b) No electronic device shall be used to question, challenge or dispute a game official's decision or judgment while the game is in progress.
- (c) For violation, the device will be removed and the team assessed a bench minor penalty for an equipment violation.

Rule 309 Adjustment to Clothing and Equipment

- (a) It shall be the player's responsibility to maintain clothing and equipment in proper condition. Play shall not be stopped, nor the game delayed, for the purpose of any player or goalkeeper making equipment or clothing adjustments. If adjustments are required, the player shall retire from the ice and be replaced by a substitute.
- (b) If it is necessary to adjust or repair any piece of goalkeeper equipment, the goalkeeper is required to retire from the ice and be replaced by a substitute or temporary goalkeeper (see Glossary) immediately.
- (c) A minor penalty for delay of game shall be assessed to a player or goalkeeper who delays the game for the purpose of adjusting clothing or equipment.

EQUIPMENT DIAGRAMS

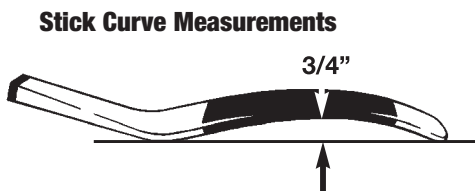
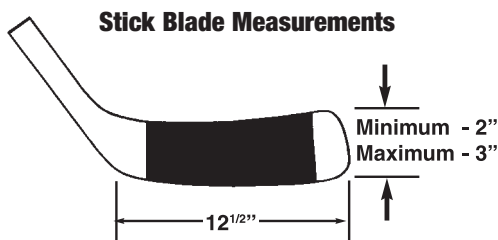

Stick Shaft Measurements

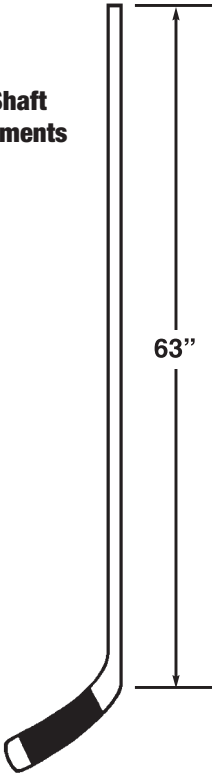

Goalkeeper Stick Shaft Measurements

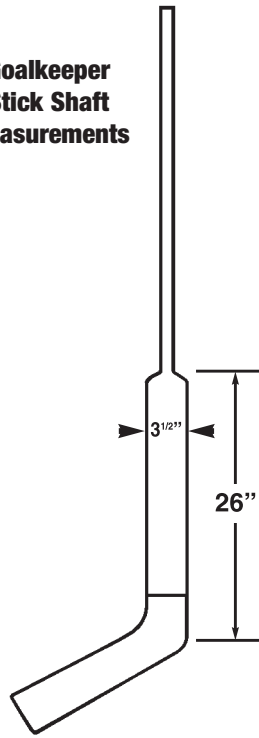

Equipment

Goalkeeper Stick Blade Measurements

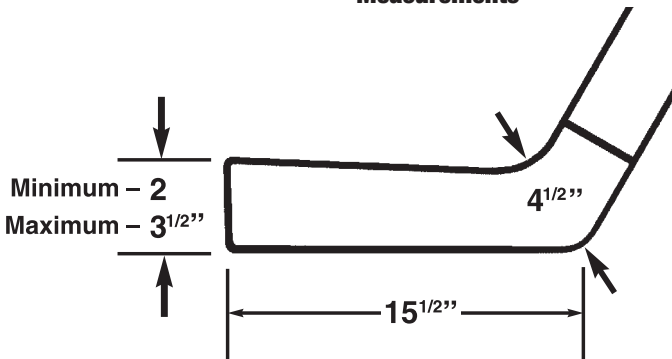

Goalkeeper Cuff and T-Trap Measurements

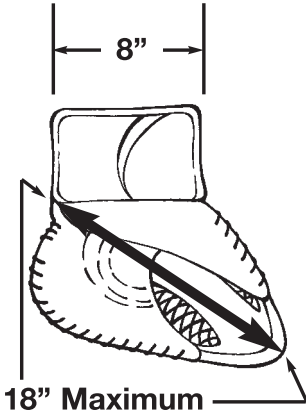

Goalkeeper Catching Glove Circumference

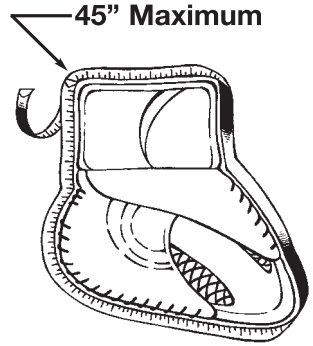

Goalkeeper Blocker Measurements

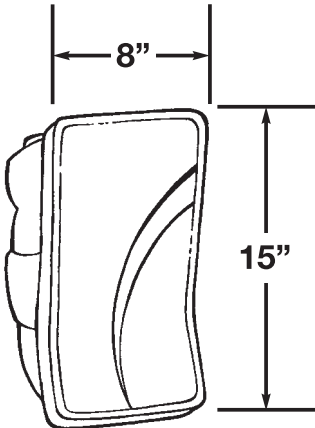

Goalkeeper Leg Pad Measurements

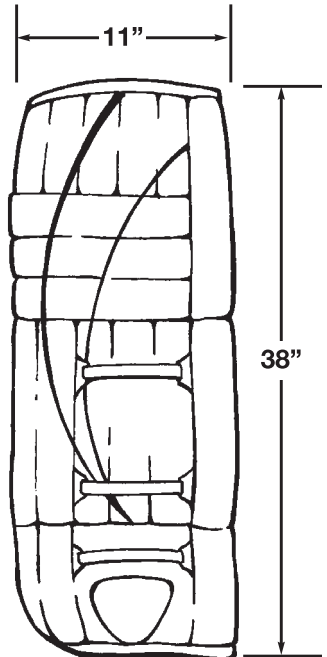

**Chest/Shoulder Protection
Width/Thickness
Front and Side Views**

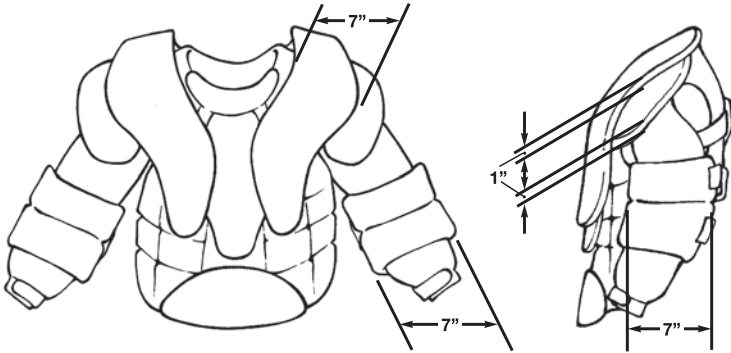

**Goalkeeper Knee/Calf
Protection Thickness**

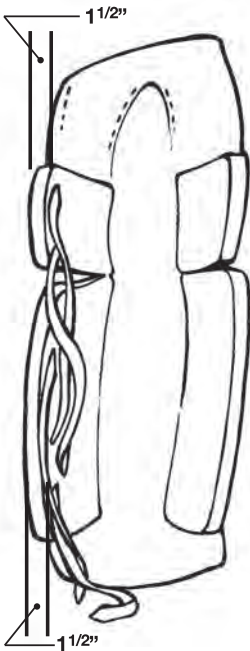

**Goalkeeper Thigh
Plate Width**

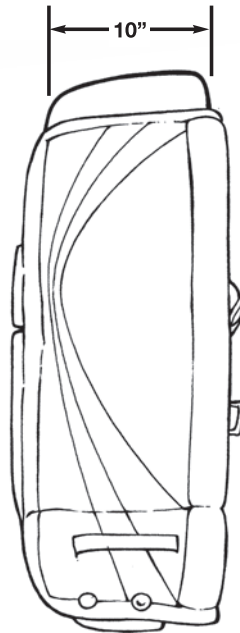

Equipment

SECTION FOUR
PENALTIES



Rule 401 Penalties

- (a) Penalties shall be actual playing time and shall be divided into the following classes:
- (1) Minor/Bench Minor Penalties
 - (2) Major Penalties
 - (3) Misconduct Penalties
 - (4) Match Penalties
 - (5) Penalty Shot

(Note 1) When play is not actually in progress and an offense is committed by any player or Team Official, the same penalty shall apply as though play were actually in progress.

(Note 2) Should a player commit multiple infractions on the same play, either before or after the Referee has stopped play, the offending player shall serve the penalties consecutively.

- (b) Any player, except in Adult age classifications, who receives five penalties in the same game shall be assessed a game misconduct penalty. Any Adult player who receives five penalties in the same game shall be immediately ejected for the remainder of the game with no further suspension.

Any Head Coach whose team, except in Adult age classifications, receives 15 or more penalties during one game shall be suspended for the next scheduled game of that team.

Rule 402 Minor Penalties

(Note) (Except for Adults) Affiliates or governing bodies are authorized to reduce the length of minor penalties to no less than one and one-half minutes for games under their jurisdiction where the period length is reduced to 15 minutes or less.

- (a) For a "MINOR PENALTY," any player, other than a goalkeeper, shall be ruled off the ice for two minutes during which time no substitute shall be permitted.
- (b) For a "BENCH MINOR" penalty one player shall be ruled off the ice for a period of two minutes, during which time no substitute shall be permitted. Any non-penalized player of the team who was on the ice at the time of the infraction, except the goalkeeper, may be designated to serve the penalty

by the Manager or Coach through the playing captain, and such player shall promptly take his place on the penalty bench.

- (c) If the opposing team scores a goal while a team is shorthanded (below the on ice numerical strength of its opponent at the time of the goal) by one or more minor penalties, one of such penalties shall automatically terminate. The penalty that terminates automatically is the first minor or bench minor penalty (non-coincidental) then being served by the “shorthanded” team. This rule shall not apply when a goal is scored on a penalty shot or an awarded goal.
- (d) When the minor penalties of two players of the same team terminate at the same time, the captain of that team shall designate which player will return to the ice first.
- (e) When a player receives a major penalty and a minor penalty at the same time, the major penalty shall be served first by the penalized player. However, if the major or match penalty is assessed under the coincidental major or match penalty rules, the minor penalty will be recorded and served first.
- (f) When an equal number of minor penalties (coincidental) are assessed to players from both teams, the penalized players shall take their place on the penalty bench and immediate substitution will take place for an equal number of minor penalties. The penalized players shall not leave the penalty bench until the first stoppage of play following the expiration of their penalties. Additional minor penalties assessed at the same stoppage that are not considered coincidental minor penalties shall be served in the normal manner.

Coincidental minor penalties shall not be taken into account for the purpose of a delayed penalty under Rule 408 (Delayed Penalties).

Rule 403 Major Penalties

- (a) For the first “MAJOR PENALTY” in any one game, any player, except the goalkeeper, shall be ruled off the ice for five minutes, during which time no substitute shall be permitted.

- (b) For the second major penalty in the same game to the same player or goalkeeper, that player shall be assessed a game misconduct penalty in addition to the major penalty. The player or goalkeeper shall be suspended for his team's next two games. This two-game suspension is in addition to any other required suspensions incurred during the same incident.
- (c) When an equal number of major penalties (coincidental), are assessed to players from both teams, the penalized players shall take their place on the penalty bench and immediate substitution will take place for an equal number of major penalties. The penalized players shall not leave the penalty bench until the first stoppage of play following the expiration of their penalties. Additional minor or major penalties assessed at the same stoppage that are not considered coincidental penalties shall be served in the normal manner.

The coincidental penalty rule shall also apply in all situations where penalties of equal duration (minor or major penalties) are assessed to both teams.

Coincidental major penalties shall not be taken into account for the purpose of a delayed penalty under Rule 408 (Delayed Penalties).

- (d) ***(For all Youth, High School and Girls' Age Classifications)*** When a player is assessed a major plus misconduct or game misconduct penalty, unless immediate substitution is permitted under the coincidental major penalty Rule 403(c), the penalized team shall immediately place a substitute player on the penalty bench and such player may not be changed.

(For Adult Classifications) When a player is assessed a major plus misconduct or game misconduct penalty, unless immediate substitution is permitted under the coincidental major penalty Rule 403(c), the penalized team shall place a substitute player on the penalty bench before the penalty expires. No other replacement for the penalized player shall be permitted to enter the game except from the penalty bench upon expiration of the penalty. For violation of this rule a bench minor penalty for illegal substitution shall be imposed.

Rule 404 Misconduct Penalties

- (a) A “MISCONDUCT” penalty involves the removal of a player, other than a goalkeeper, from the game for a period of 10 minutes with immediate substitution taking place on ice. A player whose misconduct penalty has expired shall remain on the penalty bench until the next stoppage of play.

Unless immediate substitution is permitted under the coincidental minor penalty rule 402(f), when a player receives a minor penalty plus a misconduct or game misconduct penalty at the same time, the penalized team shall immediately place an additional non-penalized player, other than a goalkeeper, on the penalty bench and such player may not be changed.

In the case where a player receives a major plus misconduct or game misconduct penalty, unless immediate substitution is allowed under the coincidental major penalty rule 403(c), the penalized team shall place a substitute player on the penalty bench immediately (**for Youth, Girls’ and High School Classifications**) or before the penalty expires (**for Adult Classifications**). No other replacement for the penalized player shall be permitted to enter the game except from the penalty bench upon expiration of the penalty.

For violation of this rule a bench minor penalty for illegal substitution shall be imposed.

For the second misconduct penalty assessed to the same player during the same game, a game misconduct penalty shall be assessed to that player in lieu of the second misconduct penalty.

- (b) A “GAME MISCONDUCT” penalty involves the suspension of a player or Team Official for the balance of the game with immediate substitution taking place on ice.

A player or Team Official incurring a game misconduct penalty shall also be suspended for his team’s next game (the game already appearing on the schedule of that team at the time of the infraction), except that when such penalty is imposed under Rule 403(b) (Second Major in Game) there shall be a minimum two-game suspension.

(Note) In all cases where a game misconduct penalty is assessed, the incident shall be reported to the proper authorities who shall have full power to impose further suspensions.

(Note 2) For all game misconduct penalties regardless of when imposed, a total of 10 minutes shall be charged in the records against an offending player.

- (c) If any Team Official is assessed a game misconduct penalty, he may not remain near the bench of his team, nor in any way attempt to direct the play of his team.

Rule 405 Match Penalties

- (a) A “MATCH” penalty involves the immediate removal of a player or Team Official for the balance of the game and a five minute time penalty shall be assessed.

(Note) For all “MATCH” penalties, regardless of when imposed, or prescribed additional penalties, a total of 10 minutes shall be charged in the records against the offending player or Team Official.

(For all Youth, High School and Girls’ Age Classifications)

Unless immediate substitution is permitted under the coincidental major penalty Rule 403(c), the penalized team shall immediately place a substitute player on the penalty bench and such player shall not be changed.

(For Adult Classifications) Unless immediate substitution is permitted under the coincidental major penalty Rule 403(c), the penalized team shall place a substitute player on the penalty bench before the penalty expires. No other replacement for the penalized player shall be permitted to enter the game except from the penalty bench upon expiration of the penalty. For violation of this rule a bench minor penalty for illegal substitution shall be imposed.

- (b) When coincidental match penalties have been imposed or when any combination of coincidental major and match penalties have been assessed to a player or players of both teams, Rule 403(c) covering coincidental major penalties will be applicable with respect to player substitutions.
- (c) A player or Team Official incurring a match penalty shall be suspended from participating in any USA Hockey games and practices until his case has been dealt with by the proper authorities. A hearing by the proper authorities shall be offered to be held (including any further disciplinary action)

within 30 days of the incident (“30-day period”) together with a decision in accordance with Bylaw 10D (Suspension Hearings/Domestic Competition Playing Rules). If extenuating circumstances prevent the proper authorities from conducting the hearing within the 30-day period, the player or Team Official shall be automatically reinstated after the 30-day period. The failure to offer the hearing shall not prohibit the hearing body from conducting the hearing after the 30-day period and imposing further disciplinary action.

(Note) The Referee is required to report all match penalties and the surrounding circumstances to the proper authorities immediately following the game in which they occur.

- (d) If any Team Official is assessed a match penalty, he may not sit near the players’ bench of his team, nor in any way attempt to direct the play of his team.
- (e) Original jurisdiction in any hearing resulting from a match penalty assessed under Rule 601(f.1) (Physical Assault of Officials) shall reside with the Affiliate.

Rule 406 Penalty Shot

- (a) If the offense for which the penalty shot was awarded was such as would normally incur a minor or bench minor penalty, the non-offending team may, prior to the penalty shot, elect that the minor or bench minor penalty be assessed to the offending player or team in lieu of the penalty shot. If the penalty shot is selected, the offending team shall not be reduced in on-ice strength as a result of the infraction.

If the offense for which the penalty shot was awarded was such as would normally incur a major or match penalty, such penalty shall be imposed in addition to the penalty shot regardless as to whether a goal was scored or not. In addition, misconduct penalties will also be served in the normal manner.
- (b) In cases where a penalty shot that has been awarded where a specific player has been fouled [Rules 610(e & f), 616(b), 629(c) and 637(a & b)], the Referee shall designate the fouled player to take the penalty shot.

In cases where a penalty shot that has been awarded where a specific player has not been fouled [Rules 205(e), 610(e & f), 614(b), 618(a) and 637(a)], the player selected to take the penalty shot shall be designated by the captain of the non-offending team from the players who were on the ice at the time the infraction occurred.

If by reason of injury the player designated by the Referee to take the penalty shot is unable to do so within a reasonable time, the shot may be taken by a player selected by the Captain of the non-offending team from the players on the ice at the time the infraction occurred.

Once the player has been designated to take the shot, either by the Referee or captain, such player may not be changed unless that player had incurred a game misconduct or match penalty prior to taking the penalty shot. In this instance, the captain of the non-offending team shall designate a player who was on the ice at the time of the infraction to take the penalty shot.

If the player designated to take the penalty shot is assessed a minor or major penalty in connection with the play prior to taking the penalty shot, he shall first be permitted to complete the penalty shot prior to taking his place on the penalty bench.

Only a player designated as a goalkeeper, substitute goalkeeper or temporary goalkeeper (see Glossary) may defend against a penalty shot.

- (c) A "Penalty Shot" shall be taken as follows: The puck shall be placed on the center ice face-off spot and on the instruction of the Referee, the player taking the shot will play the puck from there and attempt to score on the goalkeeper. Once the player taking the shot has touched the puck, it must be kept in motion towards the opponent's goal line and once it is shot the play shall be considered complete. No goal can be scored on a rebound of any kind and any time the puck crosses the goal line the shot shall be considered complete.

The goalkeeper must remain in his crease until the player taking the penalty shot has touched the puck. The goalkeeper may attempt to stop the shot in any manner except by throwing his stick or any object, in which case a minor penalty shall be assessed to the goalkeeper.

While the penalty shot is being taken, players from both teams must be on their players' benches.

When an infraction occurs calling for a penalty shot during actual playing time, the shot will be taken immediately upon completion of the play (delayed whistle by the Referee). The time required to complete the penalty shot shall not be included in the regular playing time.

If a goal is scored from a penalty shot, the puck shall be faced-off at center ice in the usual way. If a goal is not scored, the puck shall be faced-off at either of the end face-off spots in the zone in which the penalty shot has been attempted.

- (d) For any violation committed by a goalkeeper during the penalty shot, the Referee shall allow the shot to be completed and if the shot fails, another penalty shot shall be awarded. Any penalties assessed will be served in the normal manner whether or not a goal is scored on the penalty shot.

If, while the penalty shot is being taken, any player of the opposing team shall have by some action interfered with or distracted the player taking the shot, and as a result the shot was failed, a second attempt shall be permitted and the Referee shall impose a misconduct penalty on the player who committed the infraction.

Rule 407 Goalkeeper Penalties

- (a) A goalkeeper shall not be sent to the penalty bench for an offense that incurs a minor, major or misconduct penalty. These penalties shall be served by another member of his team who was on the ice when the offense was committed. The player shall be designated by the Coach of the offending team through the captain and such substitute may not be changed.
- (b) Should a goalkeeper incur a game misconduct or a match penalty, his place will be taken by a member of his own team, or by a substitute or temporary goalkeeper who is available, and such player will be allowed the goalkeeper's full equipment.

Any other penalties assessed to a goalkeeper, including minor, major, misconduct or match penalties, shall be served by another member of the team on the ice at the time the offense was committed. The player shall be designated by the

Coach of the offending team through the captain and such substitute may not be changed.

(Note) All penalties assessed to a goalkeeper, regardless of who serves the penalty, or any substitution, shall be charged in the records against the goalkeeper.

- (c) If a goalkeeper deliberately participates in the play in any manner when he is beyond the center red line, a minor penalty shall be assessed.

Rule 408 Delayed Penalties

- (a) If a third player shall be penalized while two players of the same team are serving non-coincidental penalties, he shall proceed to the penalty bench immediately and may be replaced by a substitute on the ice. However, the penalty time of the third player shall not begin until the first such penalty has expired.
- (b) When either team has three players serving penalties at the same time under this rule and a substitute is on the ice to replace the third penalized player, no players may return to the ice upon expiration of their penalty following a stoppage of play.

However, if the penalized team is entitled to have more players on the ice as a result of expired penalties, the Penalty Timekeeper shall permit the player(s) to return in the order in which their penalty has expired.

When the penalties of two players of the same team expire at the same time, the captain shall designate which player will return to the ice first.

- (c) When a major and a minor penalty are imposed at the same time on players of the same team, the Penalty Timekeeper shall record the minor as being the first of such penalties.
- (d) Where it is required to determine which of the penalized players shall be designated to serve the delayed penalty, the penalized team shall have the right to make such designation provided such designation is not in conflict with Rule 402 (Minor Penalties).

*(Note) This applies to the case where the penalties are assessed to **different** players of the same team. See also Rule 402(e)(Minor Penalties).*

Rule 409 **Calling of Penalties**

- (a) Should an infraction of the rules be committed by a player of the team in possession and control of the puck, the Referee shall immediately stop play and assess the penalty(s) to the offending player(s).

Should an infraction of the rules be committed by a player of a team NOT in possession and control of the puck the Referee shall signal a delayed penalty. Play will be stopped immediately when the offending team gains possession and control of the puck and the penalty(s) assessed to the offending players(s).

(Note 1) Play is stopped when the offending team gains “possession and control” of the puck as defined in the Glossary. A rebound off of the goalkeeper or accidental contact with any opposing player is not considered to establish “possession and control.”

(Note 2) There shall be no delayed penalty signal given by the Referee for a misconduct or game misconduct penalty under this section.

The resulting face-off will take place at the nearest face-off location where play was stopped unless:

- (1) The stoppage occurred in the attacking zone of the team who committed the infraction – in which case the face-off will take place at the nearest neutral zone face-off spot.
 - (2) Or the stoppage of play was the result of a non-offending team icing the puck, shooting the puck out of play from their defending zone or the puck becomes unplayable in the defending zone, in which case the face-off will take place at the nearest neutral zone face-off spot.
- (b) If the penalty or penalties to be imposed are minor penalties and a goal is scored on the play by the non-offending team, the first minor penalty shall be imposed and recorded but shall be deemed expired. All other penalties shall be imposed in the normal manner regardless of whether or not a goal is scored.

If the Referee signals an additional minor penalty(s) against a team that is already shorthanded (below the

numerical strength of its opponent on the ice at the time of the goal) because of one or more minor or bench minor penalties, and a goal is scored by the non-offending team, the goal shall be allowed. The delayed penalty(s) shall be assessed and the first non-coincidental minor penalty already being served shall terminate automatically under Rule 402(c) (Minor Penalties).

- (c) If the Referee has signaled a delayed penalty and the puck shall enter the goal of the non-offending team as the direct result of the action of a player of that team, the goal shall be allowed and the penalty signaled shall be imposed in the normal manner.
- (d) All minor and bench minor penalties occurring after a goal has been scored or during the stoppage of play when a penalty shot is being attempted, shall be served in the normal manner under this rule.

Rule 410 Supplementary Discipline

- (a) In addition to the suspensions imposed under these rules, the proper disciplinary authority, at its discretion and after the game has been completed, may investigate any incident that occurs in connection with any game. Any incident that occurs prior to, during, or after the game is subject to review regardless of whether the action was penalized by the Referee.
- (b) Suspensions imposed during a USA Hockey governed playoff event (State, District or National Championships) must be served during that same event where the suspension occurred. If the length of suspension carries beyond that event for an advancing team, the Discipline Committee of the following Championship shall be the sole authority in determining the eligibility of the individual(s).
- (c) In the case of a Match penalty, the proper disciplinary authority (as defined in the Glossary) shall be required to conduct any disciplinary actions in accordance with the provisions of USA Hockey's "Resolutions of Disputes, Arbitration and Suspensions" section of the current *USA Hockey Annual Guide*.

Rule 411 Progressive Suspensions

(Note) USA Hockey is committed to providing a safe and fair environment for all participants. While the vast majority of players participate within the rules and respect the game and their opponents, USA Hockey recognizes the need to hold those players and coaches deemed to be repeat offenders accountable for their actions. Beginning with the 2014-15 playing season, the Progressive Suspensions rule will take effect nationally.

- (a) Any player who receives their third major penalty during the same season for any combination of aggressive infractions listed below shall receive an additional three-game suspension. For any player who receives their fourth major penalty in this category, the player shall receive an additional five-game suspension. Any player who receives their fifth major penalty in this category during the same season shall be suspended until a hearing is conducted by the proper authorities (USA Hockey Affiliate). These designated game suspensions shall be in addition to any other suspensions imposed through the official playing rules. The aggressive infractions that fit into this category are:

- Rule 603 Boarding
- Rule 604 Body Checking (Body Contact categories)
- Rule 606 Butt-Ending
- Rule 607 Charging
- Rule 608 Checking From Behind
- Rule 609 Cross-Checking
- Rule 611 Elbowing
- Rule 619 Head-Butting
- Rule 620 Head Contact
- Rule 621 High Stick
- Rule 627 Kicking
- Rule 628 Kneeing
- Rule 634 Slashing
- Rule 635 Spearing
- Rule 639 Tripping/Clipping/Leg Checking
- Rule 640 Unnecessary Roughness (Roughing)

(Note) A separate progressive suspension rule for Fighting is covered under Rule 615(f) Fighting.

- (b) Any team that receives three major penalties in the same game shall have its Head Coach suspended for the next game of that team. For any subsequent game where that team receives three or more major penalties in the same game, the Head Coach shall serve a three-game suspension. For a third game with three or more major penalties by the same team during the same season, the Head Coach shall be suspended indefinitely until a hearing has been conducted by the proper authorities (USA Hockey Affiliate).

(Note) The role of the Official is to enforce all playing rules at all times and they are expected to strictly enforce playing rules that fall under the aggressive infraction category. Players and coaches must be held accountable for dangerous actions and the onus is on them to teach and play the game within the rules. Officials are required to submit a game report immediately following the game for any major penalty falling in the aggressive infraction category, game misconduct or match penalty that is assessed.

SECTION FIVE
OFFICIALS



Rule 501 Appointment of Officials

- (a) **Referee Systems** – The three-official system (one Referee/two Linesman) and the two-official system (two Referees) are the only approved systems for USA Hockey sanctioned games. When the two official system is used, the duties of the Linesmen will be carried out by both Referees.

However, Districts or Affiliates are authorized to use the four-official system (two Referee/two Linesman) for games involving teams in the Youth and Girls' 16 & under age classifications and older (including High School and Adults).

- (b) For Regional and National Championships, the District Referee-in-Chief or his duly appointed representative shall appoint all on-ice officials. Required off-ice officials shall be assigned by the respective Tournament Officials.
- (c) All On-Ice Officials shall wear black trousers and an official sweater with the current USA Hockey officiating crest on the left chest of the sweater during all games. Any other crest that is worn must be located on either arm of the sweater. The wearing of nameplates shall be regulated by each League.

Each official is required to wear a black hockey helmet, with chin strap properly fastened, and a half-shield visor properly attached to their helmets.

- (d) If for any reason, the on-ice officials appointed are prevented from appearing, the Managers or Coaches of the two teams shall agree on a Referee and Linesmen (three-official system) or two Referees (two-official system). If unable to agree, they shall appoint a player from each team to serve in this capacity. If the regularly appointed officials appear during the progress of the game, they shall immediately replace the temporary officials.

If one of the officials (three-official system) is unable to participate or finish the game, the Referee has the authority to appoint another official, if he deems necessary. Otherwise, the game shall continue with one Referee and one Linesman or two Referees as mandated by the local governing body.

- (e) Should an Official accidentally leave the ice or receive an injury that incapacitates him from discharging his duties while play is in progress, the play shall be immediately stopped by an On-Ice Official.

(Note) If an On-Ice Official is bleeding, the Official shall seek treatment at the next stoppage of play to stop the bleeding and cover the cut or abrasion before continuing. It is required that any affected equipment/uniform be properly decontaminated or exchanged.

Rule 502 Referee

- (a) The "REFEREE" shall have general supervision of the game and his decision shall be final in all matters occurring before, during or after the game. The role of the official is to "enforce" the rules of the game and in doing so shall have full authority over all participants.

The Referee may not change his decision, or that of any other official, after the resumption of play following the rendering of the original decision.

- (b) The Referee shall order the teams on the ice at the appointed time for the beginning of a game and for the start of each period. On-Ice Officials should enter the ice surface prior to warm-ups and remain on the ice at the conclusion of each period until all players have exited to their dressing rooms. Penalties may also be assessed during the warm-up period.

Prior to the start of the game, the Referee shall confirm that the required off-ice officials are in their proper position and that the timing and signaling equipment is working properly.

- (c) It shall be the Referee's duty to impose such infractions as outlined in the rules and give the final decision in matters pertaining to disputed goals after consultation with the Linesmen and/or Goal Judges. He shall be responsible for ensuring each player is wearing the required protective equipment in its intended manner.

The Referee shall announce to the appropriate off-ice official all goals and assists legally scored as well as penalties imposed. He shall request, at the first stoppage of play, to have announced the reason for disallowing a goal in every instance when the goal light is turned on in error during play.

- (d) The Referee shall see to it that players of opposing teams are separated on the penalty bench to prevent contact.

- (e) At the conclusion of the game, the Referee shall check the official scoresheet, including team rosters and players in uniform, for accuracy prior to signing,

Rule 503 Linesman

- (a) The duties of the “LINESMAN” are to determine any infractions of the rules concerning off-side play at the blue lines or any violation of the “Icing the Puck” rule. He shall, when requested to do so by the Referee, give his version of any incident that may have taken place during the playing of the game.
- (b) He shall conduct face-offs at all times, except at the start of the game, at the beginning of each period and after a goal has been scored.
- (c) The Linesman shall stop play for the following situations:
- (1) The puck goes outside the playing area (Rule 631(a)).
 - (2) The puck is interfered with by any ineligible person.
 - (3) The puck is played with a stick above the height of the shoulder (Rule 621(c)).
 - (4) The puck has been illegally passed with the hand (Rule 618(b)).
 - (5) The goalpost has been displaced from its normal position.
 - (6) When in the vicinity of the goal, the puck has entered the goal and is unobserved by the Referee.
 - (7) Off-sides occurring at the face-off circles (Rule 613(b)).
 - (8) Premature substitution of the goalkeeper (Rule 205(b)).
 - (9) Injured players (Rule 206(a)).
 - (10) Interference by spectators (Rule 626(a)).
- (d) The Linesman shall stop play and report to the Referee any infraction of the following rules:
- (1) Too many players on the ice (Rule 205(a)).
 - (2) Articles thrown on the ice from the vicinity of the players’ or penalty bench (Rule 601(b.3)).
 - (3) Delaying the game by deliberately displacing the goal post (Rule 610(c)).
- (e) The Linesman shall report to the Referee at the next stoppage of play his version of any infraction of the rules that he believes constitutes a bench minor, major, match,

misconduct, game misconduct or penalty shot under these rules. In addition, the Linesman shall give his version of any Injury Potential Penalty (see Glossary) that occurs behind the play and is not observed by the Referee. The Referee, at his discretion, may assess a penalty for such infractions.

Rule 504 Goal Judge

- (a) When mandated by the local governing body, there shall be one "GOAL JUDGE" stationed out of play and behind each goal during the game. The area reserved for the Goal Judges shall be protected from spectators so there can be no interference with the performance of their duties.
- (b) The duty of the Goal Judge is to determine whether the puck has completely crossed the goal line between the goal posts and under the crossbar. His decision is simply "goal" or "no goal" and he shall report his version when requested to do so by the Referee.

Rule 505 Official Scorer

- (a) Before the start of the game, the "OFFICIAL SCORER" shall obtain from the Manager or Coach of both teams a list of all eligible players of each team. The Official Scorer shall secure the names of the Captain and Designated Alternate(s) from the Manager or Coach of each team and will indicate each by placing the letter "C" or "A" opposite their names on the scoresheet.

(For all Youth and Girls' Classifications) Prior to the start of the game, the Official Scorer shall obtain on the scoresheet the signatures of all coaches of each team, one of whom shall be designated as Head Coach, along with the CEP card number, CEP level and the year the CEP level was attained for each coach.

- (b) The Official Scorer shall keep a record of each goal scored by indicating those player(s) who are credited with scoring the goal and any assists and have announced over the public address system. No request for changes to the officials scoring shall be considered unless they are made at or before the conclusion of the game.

He shall indicate on the scoresheet those players from each team who actually participated in the game.

He shall note on the scoresheet the time any substitute or temporary goalkeeper has entered the game and designate any goal scored when the goalkeeper has been removed from the ice.

- (c) Upon the immediate conclusion of the game, the Official Scorer shall also prepare the Official Scoresheet for signature by the Referee and forward it to the proper authorities.

Rule 506 Game Timekeeper

- (a) The "GAME TIMEKEEPER" shall signal the Referee and the competing teams for the start of the game and each succeeding period. To assist in assuring the prompt return to the ice of the teams and On-Ice Officials, the Game Timekeeper shall give a preliminary warning three minutes prior to the resumption of play in each period.

If the rink is not equipped with an automatic horn, or if such device fails to function, the Game Timekeeper shall signal the end of each period by blowing a whistle.

He shall have announced on the public address system, at the appropriate time in each period, that there is one minute remaining to be played in the period.

- (b) The Game Timekeeper shall note the time and then notify the Referee of a malfunction of the clock, or any other equipment, during the next normal stoppage of play. In the event of any dispute regarding time, the matter shall be referred to the Referee for adjustment and his decision shall be final.

Rule 507 Penalty Timekeeper

- (a) The duties of the "PENALTY TIMEKEEPER" include maintaining a record, on the official forms provided, of all penalties imposed including the names/numbers of the players penalized, the infraction assessed, the duration of each penalty and the time at which the penalty was assessed.

He shall report to the Referee any violation of Rule 401(b) and 403(b).

- (b) The Penalty Timekeeper shall check and ensure that the time served by all penalized players is correct. He shall be responsible for the correct posting of all penalties on the

scoreboard and shall promptly call to the attention of the Referee any discrepancy between the time recorded on the clock and the official correct penalty time. He shall, upon request, give a penalized player correct information as to the unexpired time of his penalty.

(Note 1) The infraction of the rules for which each penalty has been imposed will be announced twice over the public address system as reported by the Referee. Where players of both teams are penalized on the same play, the penalty to the visiting player will be announced first.

(Note 2) Misconduct penalties and coincidental minor or major penalties should not be recorded on the timing device, but such penalized players should be alerted and released at the first stoppage of play following the expiration of their penalties.

- (c) Only penalized players and off-ice official(s), are permitted to occupy the penalty bench. Play shall not continue until any unauthorized persons have been removed.

Rule 508 Proper Authorities

- (a) The term “proper authorities” or “proper disciplinary authority” as applied under these rules is defined as the governing body of the team or teams involved, as determined by the Affiliate.

SECTION SIX
PLAYING RULES



Rule 601 Abuse of Officials and Other Misconduct

(Note) For the enforcement of this rule, the following guidelines shall apply.

A bench minor penalty shall be assessed for actions that occur on or in the immediate vicinity of the player's bench (off the ice) or when the player in question is not readily identifiable. Any unsportsmanlike conduct by a Team Official would also warrant a bench minor penalty.

A minor penalty or misconduct penalty should be assessed for actions that occur on the playing surface or in the penalty bench area.

- (a) A minor penalty for unsportsmanlike conduct shall be assessed to any player who commits the following actions:
- (1) Disputes the rulings of any official.
 - (2) Taunts or incites an opponent.
 - (3) Creates a disturbance during the game.
 - (4) Shoots the puck after the whistle, if in the opinion of the Official such shot was avoidable.

A misconduct penalty shall be assessed to any player who persists in such conduct and any further dispute by the same player shall result in a game misconduct penalty being assessed.

(Note) If occurring after the game, the above actions shall be initially penalized as a misconduct penalty.

- (b) A bench minor penalty shall be assessed to any team who's players or team officials commit the following actions while on the player's bench:
- (1) Using obscene, profane or abusive language to any person.
 - (2) Using the name of any official in a loud or abusive manner.
 - (3) Throwing any object onto the playing area during the progress of the game or during a stoppage of play.
 - (4) Banging the boards with a stick or other object at anytime.
 - (5) Using threatening or abusive language or gestures directed at an opponent.

- (6) Interfering in any non-physical manner with any game official, including off-ice officials, in the performance of their duties.

(Note) If any of the above actions are committed by a player who is on the players' bench and is readily identifiable, they shall be assessed a misconduct penalty under sub-section (c) of this rule.

- (c) A misconduct penalty shall be assessed to any player who commits the following actions:
- (1) Persists in any conduct where they were previously assessed a minor penalty for unsportsmanlike conduct.
 - (2) Using obscene, profane or abusive language to any person anywhere in the rink before, during or after the game.
 - (3) Intentionally knocking or shooting the puck out of the reach of an official who is retrieving it during a stoppage of play.
 - (4) Not proceeding directly and immediately to the penalty bench or to the dressing room, after being penalized and ordered to do so by the officials (equipment shall be delivered to him by a teammate, if necessary).
 - (5) Entering or remaining in the Referee's Crease, unless invited to do so.
 - (6) Interfering in any non-physical manner with any Game Official including the Referee, Linesman, Timekeepers or Goal Judges in the performance of their duties.
- (d) A misconduct or game misconduct, at the discretion of the Referee and based on severity, shall be assessed to any player who commits the following actions:
- (1) Touches or holds any official with his hand or stick.
 - (2) Attempts to continue an altercation after been ordered to stop, or resists the linesman in stopping the altercation.
 - (3) Intentionally bangs the boards or protective glass or goal frame with his stick or any other object at anytime. If done in protest of an officials' decision, an additional minor penalty for unsportsmanlike conduct shall also be assessed.

- (e) A game misconduct penalty shall be assessed to any player or team official who is guilty of the following actions:
- (1) Persists in any course of conduct for which he has previously been assessed a misconduct penalty (player) or bench minor penalty assessed to the team (Team Official).
 - (2) Uses obscene gesture or a racial/ethnic slur anywhere in the rink before, during or after the game.
 - (3) Interferes in any physical manner with any game official, including off-ice officials, in performing their duties.
 - (4) A player who receives their second misconduct penalty during the same game shall be assessed a game misconduct penalty in lieu of the second misconduct penalty.
- (f) A match penalty shall be assessed to any player or team official who commits the following actions:
- (1) Deliberately inflicting physical harm, or attempting to do so, to any game official, including off-ice officials.
(Note) Any match penalty assessed under this rule must be reported via written game report by the officials to the USA Hockey District Referee-in-Chief within 48 hours.
 - (2) Deliberately injuring, or attempting to do so, any opposing player or team official.
 - (3) Behaving in any manner that is critically detrimental to the conducting of the game, including spitting at an opponent, spectator, game or team official, or verbally threatening a Game Official, opposing Team Official or opposing player with physical harm.
- (g) The use of tobacco products or alcoholic beverages by any player or team official is prohibited in the rink area, including the bench areas and off-ice official area. A warning shall be issued by the Referee for the first offense by any participant and any subsequent violations by the same team shall result in a bench minor penalty being assessed.

Rule 602 Attempt to Injure/Deliberate Injury of Opponents

- (a) A match penalty shall be assessed to any player or team official who deliberately injures or attempts to injure any opposing player or team official.

In all cases when a match penalty is assessed, a game report shall be filed with the proper authorities for further disciplinary action.

(Note) All incidents of attempt to injure/deliberate injury of game officials should be penalized under Rule 601(f.1).

Rule 603 Boarding

- (a) A minor plus a misconduct or major plus game misconduct penalty shall be assessed to any player who commits any action that causes an opponent to be thrown violently into the boards.

“Rolling” an opponent along the boards where he is attempting to go through too small an opening is not considered boarding.

- (b) A major penalty plus game misconduct penalty shall be assessed to any player who injures an opponent as a result of boarding.
- (c) A match penalty for attempt to injure or deliberate injury to an opponent may also be assessed for boarding.

Rule 604 Body Checking (Body Contact Categories & Non-Check Adult Classifications)

(Note) For the purpose of this rule, USA Hockey has identified two different categories of play. They are Body Contact (where Body Checking is prohibited) and Body Checking (where a legal body check is permissible). Please refer to the Glossary for specific definitions of Body Contact and a Body Check.

- (a) Body checking is prohibited in the 12 & under youth age classification and below and all Girls’/Women’s age classifications. These levels would be considered the Body Contact Category of play.

Body checking is also prohibited in all non-check Adult classifications.

A local governing body may prohibit body checking in any classification.

- (b) Anytime a team from a Body Contact category (see subsection (a) above) plays a team from a Body Checking category, checking shall be prohibited under this rule.
- (c) A minor or major penalty shall be assessed to a player who body checks an opponent in a Body Contact category or non-check Adult classification.

(Note) Body Contact hockey does not mean “no contact.” There will be legal body contact (see Glossary) within the rules in Body Contact categories. Legal body contact shall not be penalized under this rule. However, deliberate physical contact with an opponent, with no effort to legally play the puck, shall be penalized.

- (d) A major plus a game misconduct penalty shall be assessed to any player who injures an opponent with a body check in a Body Contact category or non-check Adult classification.

Rule 605 Broken Stick

- (a) Any player whose stick is broken must drop his stick prior to participating in the play. A minor penalty for an equipment violation shall be assessed for participating in play with a broken stick.

A broken stick is one that, in the opinion of the Referee, is unfit for normal play.

- (b) A replacement stick for any player who is no longer in possession of a stick may only be obtained from the player's bench or from a teammate on the ice. A minor penalty for an equipment violation shall be assessed to a player who receives a replacement stick illegally, unless the team is assessed a bench minor penalty under Rule 601(b.3) Throwing Articles into the Playing Area. In this instance, the player receiving the thrown stick shall not be penalized.
- (c) A goalkeeper whose stick is broken may not go to the players' bench for a replacement during a stoppage of play, but must receive his stick from a teammate. For an infraction of this rule a minor penalty for delay of game shall be assessed to the goalkeeper.

Rule 606 Butt-Ending

- (a) A major plus a game misconduct penalty shall be assessed to any player who “butt-ends” or attempts to “butt-end” an opponent.
An attempt to “butt-end” shall include all cases where a “butt-end” gesture is made regardless of whether body contact is made or not.
- (b) A match penalty for attempt to injure or deliberate injury to an opponent may also be assessed for butt-ending.

Rule 607 Charging

- (a) A minor plus a misconduct or a major plus a game misconduct penalty shall be assessed to any player who runs or jumps into an opponent or who takes more than two fast strides in delivering a body check (charging).
- (b) A major penalty plus game misconduct penalty shall be assessed to any player who injures an opponent as a result of charging.
- (c) A minor plus a misconduct or a major plus a game misconduct penalty shall be assessed to a player who body checks or charges a goalkeeper while the goalkeeper is within his goal crease or privileged area.
- (d) A goalkeeper is NOT “fair game” because he is outside his privileged area. A penalty for interference or charging should be called in every case where an opposing player makes unnecessary contact with a goalkeeper. Likewise, Referees should be alert to penalize goalkeepers for any infractions they commit in the vicinity of the goal.

(Note 1) For the purpose of this rule, any accidental or unavoidable contact that occurs with the goalkeeper shall be penalized under the Interference rule. Any deliberate body contact or check that is delivered to the goalkeeper shall be penalized as Charging.

(Note 2) The goalkeeper’s “Privileged Area” is an area outlined by connecting the end zone face-off spots with an imaginary line and imaginary lines from each face-off spot running perpendicular to the end boards.

- (e) A match penalty for attempt to injure or deliberate injury to an opponent may also be assessed for Charging.

Rule 608 Checking from Behind

- (a) A minor plus a misconduct penalty, or a major plus a game misconduct penalty, shall be assessed to any player who body checks or pushes an opponent from behind.
- (b) A major penalty plus game misconduct penalty shall be assessed to any player who injures an opponent as a result of checking from behind or who body checks or pushes an opponent from behind causing them to go head first into the boards or goal frame.
- (c) A match penalty for attempt to injure or deliberate injury to an opponent may also be assessed for checking from behind.

Rule 609 Cross-Checking

- (a) A minor or a major penalty shall be assessed to a player who delivers a check to an opponent using the stick with both hands on the stick and no portion of the stick on the ice (cross-checking).
- (b) A major plus a game misconduct penalty shall be assessed to any player who injures an opponent as a result of cross-checking.

Rule 610 Delaying the Game

- (a) A minor penalty shall be assessed to any player or goalkeeper who deliberately freezes the puck along the boards or goal frame for the purpose of delaying the game.
- (b) A minor penalty shall be assessed to a goalkeeper who has an opportunity to play the puck prior to being pressured by an attacking player, but instead intentionally causes a stoppage of play.
- (c) A minor penalty shall be assessed to any player or goalkeeper who delays the game by deliberately shooting or batting the puck outside the playing area, including after a stoppage of play.

(d) A minor penalty shall be assessed to a goalkeeper who shoots the puck directly (non-deflected) outside of the playing area, except when the puck inadvertently leaves the playing area in a location that is not protected by glass or screen.

(e) Play shall be stopped immediately when the goal frame has been displaced from its normal position. A minor penalty shall be assessed to any player (including a goalkeeper) who deliberately displaces the goal frame.

If the defending team deliberately displaces the goal frame during a breakaway (see Glossary) or deprives the attacking team of an immediate scoring opportunity, a penalty shot/optional minor penalty shall be awarded to the player in possession of the puck.

If the goal frame is deliberately displaced in the last two minutes of the game or anytime in overtime, a penalty shot/optional minor penalty shall be assessed.

If a player on the defending team deliberately displaces the goalpost when the goalkeeper has been removed, if in the opinion of the Referee, the puck would have entered the goal – thereby preventing an obvious and imminent goal – a goal shall be awarded in lieu of the penalty shot.

(f) If a goalkeeper (all classifications) or player (excluding Adults) deliberately removes their helmet/facemask during a breakaway (see Glossary), a penalty shot/optional minor penalty shall be awarded.

If a goalkeeper (all classifications) or player (excluding Adults) deliberately removes their helmet/facemask during the last two minutes of the game or anytime during overtime, a penalty shot/optional minor penalty shall be assessed.

(g) A minor penalty for delay of game shall be assessed to a goalkeeper who drops the puck into his pads or onto the goal net or deliberately piles up snow or obstacles near the goal that, in the opinion of the Referee, could prevent the scoring of a goal

(h) A bench minor penalty shall be assessed to any team, after warning by the Referee, that fails to place the correct number of players on the ice and commences play or that causes any delay by making additional substitutions or attempts to delay the game in any manner.

Rule 611 Elbowing

- (a) A minor or a major penalty shall be assessed to any player who body checks an opponent using his elbow.
- (b) A major plus a game misconduct penalty shall be assessed to any player who injures an opponent as the result of a foul committed by elbowing.

Rule 612 Face-Off Locations

- (a) The puck shall be dropped at the center ice face-off spot at the start of each period, after a goal is scored and in situations where a premature substitution of the goalkeeper has occurred when play has been stopped on the attacking side of the center red line.
- (b) A last play face-off will take place in any instance where a stoppage of play occurs as a result of the actions of both teams or if play is stopped for any reason other than what is specified in the rules.

A last play face-off is defined as the nearest end zone or neutral zone face-off spot, or the nearest point along an imaginary line of each side of the ice connecting the end zone face-off spot where the puck was last played.

When a stoppage of play occurs between the end zone face-off spots and the nearest end boards calling for a last play face-off, the face-off will take place at the nearest end zone face-off spot.

- (c) When a stoppage of play occurs as the result of any action by the attacking team in the attacking zone, the ensuing face-off will take place at the nearest neutral zone face-off spot.
- (d) When a stoppage of play takes place in an end zone followed by a gathering of players, a face-off at the nearest neutral zone face-off spot shall occur if any attacking player enters the end zone further than the outer edge of the face-off circles nearest the blue line.
- (e) When a goal is disallowed as a result of the actions of the attacking team, the ensuing face-off will take place at the nearest neutral zone face-off spot, unless otherwise specified in these rules.

- (f) If the puck shall illegally enter the goal as a result of deflecting directly off an official anywhere on the ice, the resulting face-off shall take place at the nearest end zone face-off spot of the goal the puck entered.
- (g) A team causing a stoppage of play shall not gain a territorial advantage with the ensuing face-off. In this instance, the ensuing face-off shall be a last play face-off.

Rule 613 Face-Off Procedures

- (a) Play shall start when one of the officials drops the puck between the sticks of two opposing players.

For face-offs occurring at a designated face-off spot, the players facing-off will stand squarely facing their opponents' end of the rink and clear of the ice markings. The stick blades of both players shall be in contact with the nearest white area of the face-off spot and clear of the center red area.

For face-offs occurring at the center ice face-off spot or in locations other than the designated face-off spots, the players facing-off shall squarely face their opponent's end of the ice and stand approximately one stick length apart.

The attacking player shall be the first to place his stick on the ice, except for a center ice face-off where the visiting team player shall be first to place his stick on the ice.
- (b) No other player shall be allowed to enter the face-off circle or come within 15 feet of the players facing-off the puck.

All other players must position themselves behind the hash marks on the outer edge of the face-off circle or stand approximately one stick length apart from the opponent.
- (c) At the conclusion of the line change procedure, the Official conducting the face-off shall blow his whistle. This will signal each team that they have no more than five seconds to line up for the ensuing face-off. Prior to the conclusion of five seconds, the Official shall conduct a proper face-off.

No substitution of players shall be permitted until the face-off has been completed and play has been resumed except when any penalty is imposed.
- (d) If a player facing-off fails to take his proper position immediately when directed by the Official, the Official may

order him replaced for that face-off by any teammate then on the ice.

If a player, other than the player facing off, fails to maintain his proper position, the center of his team shall be ejected from the face-off.

A second violation of any of the provisions of this subsection by the same team during the same face-off shall result in a minor penalty for delay of game being assessed to the player committing the second violation.

- (e) A minor penalty for interference shall be assessed to any player facing-off who makes any physical contact with his opponent's body by means of his own body or by his stick except in the course of playing the puck after the face-off has been completed.

Rule 614 Falling on Puck

- (a) A minor penalty for delay of game shall be assessed to a player other than the goalkeeper who deliberately falls on or gathers the puck into his body, deeming the puck unplayable and causing a stoppage of play.

(Note) Any player who drops to his knees to block a shot should not be penalized if the puck is shot under him or becomes lodged in his clothing or equipment.

- (b) A penalty shot/optional minor penalty shall be assessed to the non-offending team when any player, except the goalkeeper, falls on the puck, gathers the puck into his body or uses the hands to hold the puck while in the goal crease. For application of this rule, the decision as to whether the puck is in the crease is made at the moment the infraction occurs.

A goal shall be awarded to the non-offending team if the goalkeeper has been removed from the ice at the time of the infraction and the action under this rule has prevented an obvious and imminent goal.

- (c) A minor penalty for delay of game shall be assessed to a goalkeeper who falls on or gathers the puck into his body and causes a stoppage of play when:
- (1) The puck is behind the goal line and his body is entirely outside of the goal crease.

- (2) He fails to play the puck with his stick when provided the opportunity to do so prior to being pressured by an attacking player.
- (3) The puck is outside the boundaries of the "goalkeeper's privileged" area.
- (4) He holds or places the puck against any part of the goal frame or boards or intentionally drops the puck on the back of the netting.

(Note) The goalkeeper's "Privileged Area" is an area outlined by connecting the end zone face-off spots with an imaginary line and imaginary lines from each face-off spot running perpendicular to the end boards.

Rule 615 Fighting

- (a) A major plus a game misconduct penalty shall be assessed to any player who engages in fighting. An additional minor penalty shall be assessed to any player who starts or instigates fighting.

A minor penalty shall be assessed to any player who drops his stick and/or removes his glove(s) during an altercation and is not a participant in the original altercation. A game misconduct penalty shall be added if, in the judgment of the Referee, such player is deemed to be the instigator of a subsequent altercation.

A minor, double minor or major plus game misconduct penalty, at the discretion of the Referee, shall be assessed to any player who, having been struck, continues the altercation by retaliating.

(Note) The Referee is provided very wide latitude in the penalties that he may impose under the rules, including Rule 601 "Abuse of Officials and Other Misconduct" in an effort to discourage fighting. This is done intentionally to enable him to differentiate between the obvious degrees of responsibility of the participants either for starting the fighting or persisting in continuing the fighting.

- (b) A major plus game misconduct penalty shall be assessed to any player involved in fighting off the playing surface, before, during or after the game.

- (c) A game misconduct penalty shall be assessed to any player whose helmet/facemask comes off their head during an altercation.
- A match penalty (*for all Youth, Girls'/Women's Classifications*) shall be assessed to any player who deliberately removes his (or opponent's) helmet/facemask prior to or during an altercation.
- A game misconduct penalty (*for Adult Male Classifications*) shall be assessed to any player who deliberately removes his (or opponent's) helmet/facemask prior to or during an altercation.
- (d) A game misconduct penalty shall be assessed to any player or goalkeeper who is the first to intervene in an altercation then in progress. This penalty is in addition to any other penalty incurred in the same incident.
- (e) A minor penalty shall be assessed to any player who fails to move immediately and directly to their players' bench (or goal crease for a goalkeeper) when instructed to do so by the Referee during an altercation.
- (f) Any player who receives a second major penalty for fighting with the same team during the same season shall receive a three-game suspension. For a third fighting major with the same team in the same season, the player shall be suspended until a hearing is conducted by the proper authorities under Rule 410 Supplementary Discipline.

Rule 616 Fouled from Behind

- (a) For the purpose of this rule a "breakaway" is defined as follows: A player who is in possession and control of the puck (see Glossary) and is beyond his defending blue line with no opponent between him and the goalkeeper.
- (b) A penalty shot/optional minor penalty shall be awarded to the non-offending team anytime a player is fouled from behind, or diagonally from behind (beyond the fouled player's peripheral vision), and is denied a reasonable scoring opportunity during a breakaway.

(Note) The intent of this rule is to restore a reasonable scoring opportunity that has been lost by reason of a foul committed from behind during a breakaway situation. This

foul from behind could include any action that would normally be deemed a penalty, including cross-checking, high sticking, holding, hooking, slashing and tripping. This penalty shall be assessed in the normal manner allowing for a “delayed penalty” and a change of possession prior to stopping play.

- (c) If the opposing goalkeeper has been removed from the ice and an obvious and imminent goal has been prevented by the fouled from behind provisions, then the Referee shall stop play and award a goal to the non-offending team.

Rule 617 Goals and Assists

(Note) It is the responsibility of the Referee to award goals and assists strictly in accordance with the provisions of this rule and his decision shall be final. In case of an obvious error in awarding a goal or an assist, corrections should be made promptly and no changes can be made to the official scoresheet once it has been signed by the Referee.

- (a) A goal shall be scored when the puck has completely crossed the goal line between the posts and under the cross bar. The player who has legally propelled the puck into the opponent's goal (or last attacking player to play the puck in cases where the puck entered the goal as a result of the actions of the defending team) shall be credited with the scoring of the goal. Up to a maximum of two assists shall be awarded to those player(s) who had possession of the puck immediately prior to the goal being scored. Only one point can be credited to any single player for a goal scored and each goal or assist shall count as one point in the respective player's record.
- (b) A goal shall be legally scored if:
- (1) The puck has been propelled into the goal by the stick of an attacking player provided it was done in accordance with rule 621 High Sticks.
 - (2) The puck enters the goal as a result of any action by the defending team.
 - (3) The puck shall have been deflected into the goal by striking any part of an attacking player.
 - (4) The puck was legally propelled into the goal crease and not covered by the goalkeeper – making the puck

available to another attacking player to propel into the goal.

- (c) A goal shall not be allowed if the following occurs:
- (1) An attacking player kicks the puck directly into the goal or a kicked puck deflects off any player, including goalkeeper, prior to entering the goal.
 - (2) The puck has been thrown or deliberately directed into the goal by any means other than a stick, even if subsequently deflecting off any player, including goalkeeper, prior to entering the goal.
 - (3) The puck was deflected into the goal directly off an official.
 - (4) The puck entered the goal while an attacking player was positioned in the crease (unless physically interfered with by a defending player causing him to be in the goal crease) or interfering with the goalkeeper (see Rule 625(b) Interference).
 - (5) The puck has not completely crossed the goal line prior to the expiration of the period.
 - (6) As otherwise specified in the Official Playing Rules.

Rule 618 Handling Puck with Hands

- (a) Play shall be stopped and a last play face-off shall occur anytime a player (except the goalkeeper) closes his hand on the puck and does not immediately drop the puck to the ice.
- A minor penalty for delay of game shall be assessed to any player, other than the goalkeeper, who picks the puck up from the ice with his hand(s) while play is in progress.
- A penalty shot/optional minor penalty shall be awarded to the non-offending team anytime a defending player, other than the goalkeeper, picks the puck up off the ice with his hand or holds the puck while play is in progress and the puck is in the goal crease. If this infraction occurs while the goalkeeper has been removed from the ice and prevents an obvious and imminent goal, a goal shall be awarded to the non-offending team.
- (b) A player or goalkeeper shall not be allowed to “bat” the puck in the air, or push it along the ice with his hand, directly to a teammate unless the “hand pass” has been initiated and completed in his defending zone, in which case play shall be allowed to continue. If the “hand pass” occurs in the neutral

or attacking zone, a stoppage of play will occur and a face-off will take place according to last play face-off rules provided no territorial advantage has been gained.

No goal can be scored as a result of the puck being propelled by the hand of an attacking player regardless if the puck enters the goal directly from the hand or deflects off of any player prior to entering the goal.

- (c) Play shall be stopped and an end zone face-off taken when a goalkeeper holds the puck for more than three seconds while being pressured. If not pressured, after a warning by the Referee, a goalkeeper shall be assessed a minor penalty for delay of game.

If a goalkeeper catches the puck and throws it forward towards his opponent's goal and it is first played by a teammate, play shall be stopped and the ensuing face-off shall be held at the nearest end face-off spot of the offending team.

Rule 619 Head-Butting

- (a) A major plus a game misconduct penalty shall be assessed on any player who "head-butts" an opponent in any manner.
- (b) A match penalty for attempt to injure or deliberate injury to an opponent may also be assessed for head-butting.

Rule 620 Head Contact

- (a) A minor plus a misconduct or major plus a game misconduct penalty shall be assessed to any player who contacts an opponent in the head, face or neck, including with the stick or any part of the player's body or equipment.
- (b) A major plus a game misconduct penalty shall be assessed to any player who injures an opponent as a result of head contact or who intentionally or recklessly contacts an opponent in the head, face or neck.
- (c) A match penalty for attempt to injure or deliberate injury to an opponent may also be assessed for head contact.

Rule 621 High Sticks

- (a) A minor or major penalty shall be assessed to any player who carries his stick above the normal height of the shoulder or who makes stick contact above the shoulder of the opponent.
- (b) A major plus a game misconduct penalty shall be assessed to any player who injures an opponent as a result of high sticking.
- (c) Batting the puck above the normal height of the shoulder with the stick is prohibited and no goal can be scored as a result of an attacking player playing the puck above the shoulder with the stick and directly entering the goal.
When the puck is played above the height of the shoulders with the stick, play shall be immediately stopped and a face-off conducted at one of the end zone face-off spots in the defending zone of the offending team unless:
 - (1) The puck is batted to an opponent who gains possession and control of the puck, in which case play shall continue, or
 - (2) A player of the defending team bats the puck into their own goal, in which case the goal is allowed.
- (d) The use of the “slap shot” in the Youth and Girls’ 10 & under age classifications and below is prohibited. When a player who, in the process of making a forehand or backhand shot or pass, raises the blade of the stick above his waist as part of the backswing, play shall be stopped immediately and a face-off is conducted at one of the end zone face-off spots of the offending team.

Rule 622 Holding an Opponent

- (a) A minor penalty shall be assessed to a player who impedes the progress of an opponent by holding.
- (b) A major plus a game misconduct penalty shall be assessed to a player who uses his hand to rub, grab or hold the facemask of an opponent.
- (c) A match penalty for attempt to injure or deliberate injury to an opponent may also be assessed for grabbing or holding the facemask.

Rule 623 Hooking

- (a) A minor or major penalty shall be assessed to a player who impedes the progress of the opponent by using the blade of their stick on the body or stick of the opponent.
- (b) A major plus game misconduct penalty shall be assessed to any player who injures an opponent as a result of hooking.

Rule 624 Icing the Puck

(Note) For the purpose of this rule, the center line shall divide the rink in half and the point of last contact with the puck shall be used to determine whether a potential icing exists. "Icing the puck shall have been completed the instant the puck has completely crossed the goal line.

- (a) When a player of a team shoots, bats with the hand or stick or deflects the puck from his own half of the ice completely beyond the goal line of the opposing team, play shall be stopped and a face-off shall take place at an end zone face-off spot in the defending zone of the offending team.

(Note) If a team ices the puck during a delayed whistle as a result of a foul committed by the opposing team, the ensuing face-off shall take place at a neutral zone face-off spot nearest the defending zone of the team icing the puck.

However, if the puck has entered the goal as a result of a legal action by the team shooting the puck, the goal shall be allowed.

- (b) Icing shall be nullified if any of the following conditions have been met:
 - (1) The offending team is shorthanded (below the on-ice numerical strength of their opponent) when the puck is shot. The determination is made at the time the penalty expires and if the puck was shot prior to the penalty time expiration, regardless as to the position of the penalized player, no icing shall be called.
 - (2) The puck is shot by an attacking player and rebounds off of the body or the stick of a defending player on their defensive half of the center red line.
 - (3) The puck travels the length of the ice as a result of either player participating in a face-off.

- (4) The puck touches any part, including stick, skates or body, of an opposing player prior to crossing the goal line.
 - (5) If, in the opinion of the Linesman, an opposing player – except the goalkeeper – has an opportunity to play the puck, and has not done so, prior to the puck crossing the goal line.
- (c) If the Officials shall have erred in calling an “icing the puck” infraction (regardless of whether either team is shorthanded) a last play face-off (end zone face-off spot nearest to the location of the puck when play was stopped) shall occur.
- (d) Any unnecessary contact with an opponent who is attempting to play the puck in an obvious icing situation shall be penalized strictly as boarding, charging or roughing.

Rule 625 Interference

- (a) A minor penalty shall be assessed to any player who interferes with or impedes the progress of an opponent who is not in possession of the puck (see Glossary). This includes the following actions which shall be penalized under this rule:
- (1) Providing a protective screen and limiting the opportunity for an opposing player to apply pressure to a teammate in possession and control of the puck.
 - (2) Making no attempt to play the puck while facing-off and instead plays the body of the opponent.
 - (3) An attacking player who no longer has possession and control of the puck initiates contact with the defending player in an effort to obstruct their ability to play the puck or an opponent.
 - (4) A defending player who changes his skating lane or foot speed in an effort to play the body of an opponent who is no longer in possession and control of the puck.
 - (5) Deliberately knocking the stick out of an opponent’s hand.
 - (6) Preventing an opponent who has dropped his stick or any other piece of equipment from retrieving it.
 - (7) Shooting, throwing or directing any object (equipment, broken stick, etc.) that may be on the ice in the direction of an opponent in an attempt to distract him.

- (8) Any player who makes physical contact, using his stick or body, in a manner that interferes with the movement of the goalkeeper, unless otherwise specified in the rules.
- (9) Any player on the players' or penalty bench who interferes, in any manner, with the movement of the puck or any opponent on the ice while play is in progress.
- (b) A face-off shall be conducted at the nearest neutral zone face-off spot anytime an attacking player stands, holds his stick, or skates through the goal crease provided the puck is in the attacking zone, the attacking team has possession of the puck and the goalkeeper is in contact with the crease.
No goal may be scored with an attacking player in the goal crease unless the puck has preceded the player(s) into the goal crease or the goalkeeper is out of the goal crease area.
However, if the attacking player has been physically interfered with by the actions of a defending player that causes him to be in the goal crease, play shall not be stopped and any legal goal scored shall be allowed.
- (c) A minor penalty shall be assessed to a goalkeeper who intentionally leaves his stick, or any portion of his stick, in front of the goal.
A goal shall be awarded to the non-offending team if the puck shall hit the stick and prevent an obvious and imminent goal, regardless as to whether the goalkeeper is on the ice, in the act of leaving the ice or off the ice.

Rule 626 Interference by Spectators

- (a) Play shall be stopped and a last play face-off will occur if any objects are thrown onto the ice that interferes with the progress of the game.
- (b) Play shall be stopped and a last play face-off will occur anytime a player is being physically interfered with by a spectator, unless his team is in possession of the puck in which case play shall be stopped upon completion of the play.

- (c) A game misconduct penalty for unsportsmanlike conduct shall be assessed to any player who physically interferes with a spectator.

(Note) The Referee shall report all incidents pertaining to this rule to the Proper Authorities who shall have full power to take further disciplinary action as deemed appropriate.

Rule 627 Kicking Opponent or Puck

- (a) A major plus a game misconduct penalty shall be assessed to any player or goalkeeper who uses their skate to "push off" an opponent.
- (b) A match penalty shall be assessed to any player or goalkeeper who kicks, attempts to kick or injures an opponent by kicking.
- (c) Kicking the puck shall be permitted provided the puck is not kicked by an attacking player and entered the goal either directly or after deflecting off any player including the goalkeeper.

Rule 628 Kneeing

- (a) A minor or a major penalty shall be assessed to any player who body checks an opponent using their knee.
- (b) A major plus a game misconduct penalty shall be assessed to any player who injures an opponent as the result of a foul committed by kneeling.

Rule 629 Leaving the Players' Bench or Penalty Bench

- (a) A major plus a game misconduct penalty shall be assessed to any player who leaves the players' bench or the penalty bench during an altercation or for the purpose of starting an altercation. These penalties are in addition to any other penalties that may be assessed during the incident.

Substitutions made prior to the altercation shall not be penalized under this rule provided the players so substituting do not enter the altercation.

- (b) No penalized player may leave the penalty bench except on the expiration of his penalty or at the end of a period.

A minor penalty shall be assessed to any player who leaves the penalty bench before his penalty has expired, unless it resulted from an error by the Penalty Timekeeper. In all situations, the player shall serve the remaining penalty time. If a Penalty Timekeeper error occurred, no additional minor penalty assessed.

(Note) In all cases where a penalized player has left the penalty bench prematurely, whether the result of Penalty Timekeeper error or not, the Penalty Timekeeper shall note the time and verbally alert the Referee who shall stop play when the offending team gains possession and control of the puck.

- (c) If a player illegally enters the game either from the players' bench or penalty bench (Timekeeper error or not), any goal that is scored by the offending team while he is illegally on the ice shall be disallowed. However, all penalties assessed to either team shall be served in the normal manner.

A penalty shot/optional minor penalty shall be awarded to the non-offending team anytime a player who is on a breakaway (see Glossary) is interfered with, in any manner, by an opposing player who has illegally entered the game.

- (d) A bench minor penalty to the team, or a game misconduct penalty to the team official, or both, shall be assessed when any Team Official enters the ice surface after the start of the period and prior to its end without the permission of the Referee.

(Note) Any incident involving a Team Official entering the ice surface without permission during the course of a game shall be reported to the Proper Authorities for further disciplinary action.

- (e) **(For Youth and All Girls'/Women Games)** Play shall be stopped and the face-off conducted at the last play face-off location anytime a team starts play with fewer players than entitled to and the additional entering player is the first to play any puck coming from his defending zone, unless he has first made skate contact with his defending zone.

Rule 630 Off-Sides

- (a) Off-sides occurs when players of an attacking team precede the puck into the attacking zone.

The position of the player's skates and the position of the puck relative to the blue line are determining factors for an "off-side" violation. A player is considered "off-side" when the player does not have skate contact with any part of the Neutral Zone or the blue line when the puck crosses the determining edge of the blue line.

(Note) The blue line is always considered to be part of the zone in which the puck is in. Therefore, when the puck is entering the attacking zone, the "determining edge" of the blue line shall be the edge closest to the attacking goal. Therefore, the determination as to whether an "off-sides" has occurred will only take place at the moment the puck has completely crossed the determining edge into the attacking zone. A player only needs to have skate contact with one skate with the blue line to be considered "on-side."

- (b) A player who is actually in possession and control of the puck prior to entering the attacking zone and precedes the puck into the zone is not considered "off-side."

Off-sides shall be waived if a player legally carries or passes the puck back into his own Defending Zone while a player of the opposing team is in the Defending Zone.

- (c) Anytime the puck is carried into the attacking zone creating an off-side play, play shall be stopped and a face-off conducted at the nearest neutral zone face-off spot.

Anytime the puck was passed or shot into the attacking zone and creates an off-side play, play will be stopped and the face-off will take place at the nearest last play face-off location where the pass or shot originated.

Anytime, in the opinion of the official, a player has created an intentional off-sides play, play shall be stopped and a face-off conducted at the nearest end zone face-off spot in the defending zone of the offending team.

(Note) An intentional off-side is one which is made for the purpose of deliberately securing an immediate stoppage of play or when an off-side play is made under conditions

where there is no effort made or possibility of completing a legal play.

- (d) **(For Adults [male and female], High School and Youth/Girls' 14 and Under Age Classifications and above only)** The Official shall signal a delayed off-side if an attacking player proceeds the puck into the Attacking Zone and the delayed off-side will be nullified if:
- (1) The puck were to exit the attacking zone.
 - (2) All attacking players are simultaneously clear of the attacking zone by making skate contact with the blue line, at the same instant.
- If any of the following conditions are met, play shall be stopped and a face-off conducted according to sub-section (c) of this rule:
- (3) An attacking player touches the puck.
 - (4) An attacking player attempts to gain possession of the puck or continues to apply pressure to the defending puck carrier.
 - (5) The puck is shot directly on goal.
- (e) If the official shall have erred in stopping play for an off-side infraction, the face-off shall take place at the nearest neutral zone face-off spot to where play was stopped.

Rule 631 Puck Out of Bounds or Unplayable

- (a) Anytime the puck goes outside the playing area, strikes any obstacles above the playing surface other than boards, glass or wire or becomes unplayable due to a defect in the playing rink, play shall be stopped and a last play face-off conducted.
- (b) Play shall be stopped immediately if the puck comes to rest in the netting on top of the goal frame.
Play shall be stopped and deemed unplayable if the puck becomes lodged in the netting outside of either goal and neither team is able to dislodge the puck within three seconds.
- (c) Play shall not be stopped if the puck comes to rest on top of the boards surrounding the playing area and is legally played by a hand or stick or if the puck strikes an official anywhere on the rink.

- (d) If an attacking player shoots the puck directly out of play, onto the netting of the goal frame or if the puck deflects out of play off of an attacking player, the face-off will take place at the nearest neutral zone face-off spot.

Rule 632 Puck in Motion or Out of Sight

- (a) The puck must be kept in motion at all times and play shall not be stopped for a frozen puck (other than goalkeeper) unless a scramble takes place where a player falls on or is knocked down on the puck.

(Note) The Referee should be aware of all circumstances and may stop play along the boards to avoid any unnecessary contact surrounding the puck.

When a stoppage of play occurs, the face-off shall take place at the point where play was stopped according to the last play face-off rules.

- (b) A minor penalty for delay of game shall be assessed to any player who intentionally falls on the puck causing a stoppage of play.

A minor penalty for delay of game shall be assessed to any player(s), including a goalkeeper, who holds or freezes the puck along the boards or goal frame in any manner causing a stoppage of play.

- (c) Play shall be stopped immediately if a puck, other than the one officially in play, shall appear on the playing surface and interferes with the progress of the game.

Rule 633 Refusing to Start Play

- (a) With both teams on the ice, after the game has started, a team for any reason refuses to play after being ordered to do so by the Referee, the Referee shall warn the Captain and allow the team 15 seconds to resume play.

A bench minor penalty for delay of game shall be assessed to the offending team who still refuses to start play and if the same team refuses to continue play, the Referee shall suspend the game and assess a match penalty to the responsible Team Official(s).

- (b) A bench minor penalty for delay of game shall be assessed to the offending team if prior to the start of the game or start of a period, one team fails to go onto the ice promptly when ordered to do so by the Referee.

A match penalty shall be assessed to the responsible Team Official(s), and the game suspended, if the same team fails to go onto the ice and start play within five minutes.

(Note) In any instance when this rule is applied, the Referee is required to report the incident to the Proper Authorities for further disciplinary action.

Rule 634 Slashing

- (a) A minor or a major penalty shall be assessed to any player who strikes or attempts to strike an opponent with his stick.
- (b) A major plus a game misconduct penalty shall be assessed to any player who injures an opponent as a result of slashing.

(Note) Referees are instructed to penalize any player who swings his stick at any opposing player (whether or not contact is made) or makes a wild swing at the puck with the intention of intimidating the opponent.

- (c) Any player who swings his stick at another player in the course of an altercation shall be assessed a game misconduct (plus any additional penalty outlined in this rule) or a match penalty.
- (d) A minor penalty shall be assessed to any player who makes stick contact with an opposing goalkeeper while he is in his goal crease and who has covered or caught the puck, regardless of whether or not the Referee has stopped play.

Rule 635 Spearing

- (a) A major plus a game misconduct penalty shall be assessed to a player who pokes or attempts to poke, whether or not contact is made, an opponent with the point of the blade of his stick.
- (b) A match penalty for attempt to injure or deliberate injury to an opponent may also be assessed for spearing.

Rule 636 Start of Game and Time of Match/Time-Outs

- (a) The game shall start at the scheduled time with a face-off conducted at the center ice face-off spot. The maximum length of a game shall be three 20-minute periods with a 15-minute intermission, allowing for an ice resurface, between each period. Each period shall start promptly at the end of the intermission with a face-off conducted at the center ice face-off spot.
- (b) Three minutes prior to the start of the game and each period, each team shall be notified so they can return to the ice in time to start the game promptly at the conclusion of the intermission. It is recommended that the intermission time be placed on the game clock in an effort to keep teams and spectators informed.

Any team that has not returned to the ice, without proper justification, and is prepared to play at the conclusion of the intermission shall, after a warning by the Official, be assessed a bench minor penalty for delay of game.

- (c) Prior to the start of the game, each team is provided an opportunity to warm-up (maximum of 20 minutes) on their half of the rink. The length of the warm-up time and decision to resurface the ice (15-minute intermission) or begin the game immediately shall be agreed upon by both teams or determined by the Proper Authorities prior to the game.
- (d) Each team shall defend the goal closest to its bench for the start of the game unless the benches are on the opposite side of the ice. Then the home team shall choose which end to defend. The teams shall switch ends for the start of each subsequent period.

The home team shall enter the ice surface first and if both teams are to leave the ice through a common exit, it is recommended that the team whose bench is closest to the exit shall leave the ice first.

- (e) If in the opinion of the Officials, conditions are more favorable at one end of the rink, the officials may have the teams change ends at the midway point of the third period and during each overtime period so each team has an equal opportunity to play with the advantage. This changing of ends should occur at the exact midpoint of the period.

If any unusual delay occurs in the first or second periods, the Officials may order the next regular intermission to be taken immediately. The remainder of the period will be completed upon the conclusion of the intermission with the teams defending the same goals. At the conclusion of that period, the teams will change ends and resume play for the next period without any delay.

If in the opinion of the officials, the playing conditions (such as ice conditions, broken boards/glass or weather) become unsatisfactory during the course of the game, the game may be suspended and the conditions reported to the Proper Authorities.

- (f) Each team is permitted one time-out of 60 seconds duration during the game whether in regulation play or overtime. For time curfew games, no time-outs shall be permitted.

Time-outs must be requested during a stoppage of play prior to the conclusion of the line change procedure. If a team were to request to use their time-out during the same stoppage of play as their opponent, this request must be made prior to the conclusion of the first time-out.

Either team may use a time-out for the purpose of warming up their goalkeeper. However, no more than four pucks per team shall be allowed for this purpose.

Non-penalized players and goalkeepers may proceed to their respective players' bench during any time-out.

Rule 637 Throwing Stick/Object

- (a) A minor penalty shall be assessed to any player on the ice who shoots or throws any portion of his stick or any other object in the direction of the puck.

(Note) When a player discards the broken portion of a stick by tossing it to the side of the rink (and not over the boards) in such a way as will not interfere with play or an opposing player, no penalty shall be assessed.

However, a penalty shot/optional minor penalty shall be awarded to the non-offending team if done in his defending zone. The Referee shall allow play to be completed and provided no goal is scored, the penalty shot/optional minor is awarded to the player who was fouled. If the player fouled is not readily identified, the Captain of the non-offending team shall select the player to take the penalty shot from those

players who were on the ice at the time the infraction occurred.

- (b) A penalty shot/optional minor penalty shall be awarded to the non-offending team anytime a player is interfered with by any object thrown or shot in his direction by a defending player or team official during a breakaway.

For the purpose of this rule a “breakaway” is defined as follows: A player who is in possession and control of the puck (see Glossary), is beyond his defending blue line with no opponent between him and the goalkeeper.

A goal shall be awarded to the non-offending team if the goalkeeper has been removed from the ice and the stick or other object is thrown or shot in the direction of the puck and prevents an obvious and imminent goal.

- (c) A misconduct penalty shall be assessed to any player who throws any portion of his stick or any other object outside of the playing area. A game misconduct penalty shall be assessed if done in protest of an official’s decision or if thrown at or in the direction of a spectator.

Rule 638 Tied Games

- (a) If the score is tied at the end of three periods and the game must be played until there is a winner, the following is recommended:
- (1) A 5-minute rest period will occur.
 - (2) The teams shall not change ends.
 - (3) A 10-minute period shall be played.
 - (4) The game will be completed once either team scores a goal (sudden victory) and that team shall be declared the winner. If no goal is scored, the same procedure shall be repeated.
- (b) Any overtime period shall be considered part of the game and all unexpired penalties shall remain in force.
- (c) If either team declines to play in the necessary overtime period or periods, the game shall be declared a loss for that team.

(Note) Affiliates and Local Governing Bodies may make their own rules regarding overtime for games under their jurisdiction.

Rule 639 Tripping/Clipping/Leg Checking

- (a) A minor or major penalty shall be assessed to any player who commits the following:
- (1) Uses his stick or any portion of his body and causes an opponent to trip or fall.
(Note) However, no penalty shall be assessed under this rule if, in the opinion of the Referee, the player was clearly hook-checking or poke-checking the puck for the purpose of gaining possession.
 - (2) Deliberately leaves his feet or lowers his body to make contact with the opponent at or below the knees (Clipping), unless done so for the purpose of blocking a shot.
 - (3) Extends his leg from the front or from behind for the purpose of tripping their opponent (Leg Checking).
 - (4) Extends the leg behind a player and takes their feet out from under them, especially when used in conjunction with a push to the chest area (Slew Foot).
- (b) A major penalty plus a game misconduct penalty shall be assessed to any player who injures an opponent as a result of tripping, clipping, leg checking or slew footing.

Rule 640 Unnecessary Roughness (Roughing)

- (a) A minor or double minor penalty shall be assessed to any player who is deemed guilty of unnecessary roughness (roughing).
Any action warranting a major penalty under this rule shall be assessed under Rule 615 (Fighting).
- (b) A minor or major penalty shall be assessed (except Adult Male Classifications) to any player who delivers an avoidable body check to an opponent who is no longer in possession and control of the puck.
- (c) A minor or major penalty shall be assessed to any player who makes avoidable physical contact with an opponent after the whistle.
- (d) A major plus a game misconduct penalty shall be assessed to any player who injures an opponent as a result of an avoidable check to a player who is not in possession and control of the puck or who makes avoidable physical contact with an opponent after the whistle.

APPENDIX I
SUMMARY OF
PENALTIES



The following summary of penalties is intended for general application of the rules. Specific situations may require different applications. All referenced rules should be consulted for exact language.

Minor Penalty

Personal Fouls

- 601(a) Unsportsmanlike Conduct
- 601(a.4) Shooting puck after whistle
- 613(e) Face-off interference
- 615(a) Instigator of fighting
- 615(e) Players not going to bench after warning during altercation
- 622(a) Holding
- 625(a) Interference
- 625(a.8) Interfering with goalkeeper in crease
- 625(a.9) Interference by player on bench
- 629(b) Leaving penalty bench prematurely
- 634(d) Stick contact with goalkeeper

Delay of Game, Player or Goalkeeper

- 309(a,c) Adjusting clothing/equipment
- 610(a) Freezing puck along boards or net
- 610(b) Goalkeeper intentionally stops play
- 610(c,d) Batting/shooting puck out of rink
- 610(e) Deliberate goal displacement
- 610(h) Continued improper face-off position
- 613(d) Second face-off violation, same team
- 614(a,c) Falling on puck
- 618(a) Picking up puck from ice
- 632(b) Freezing puck along boards

Goalkeeper Infractions

- 303(g) Wearing illegal equipment
- 406(c) Thrown stick during penalty shot
- 407(c) Participating in play across center line
- 605(c) Going to bench for stick at stoppage
- 610(g) Piling up obstacles in front of goal
- 610(g) Dropping puck onto goal netting
- 615(e) Leaving crease area during altercation
- 618(c) Holding puck more than three seconds

Stick and Equipment Violations

- 301(c) Playing with an illegal stick
- 301(c) Player playing with goalkeeper stick
- 301(e) Playing with more than one stick
- 304(a) Playing without helmet/facemask
- 304(b) Equipment not worn under uniform
- 605(a) Playing with a broken stick
- 605(b) Receiving an illegal stick
- 615(a) Dropping glove(s)/stick in altercation
- 637(a) Throwing a stick (non-Penalty Shot)

Bench Minor Penalty

- 104(c) Goalkeeper warm-up area
- 203(a) Roster addition during game
- 204(b) Improper goalkeeper substitution
- 205(a) Too many players on the ice
- 205(c) Goalkeeper to bench at stoppage
- 205(d) Illegal entry from penalty bench
- 206(d) Injured/penalized player returns prematurely
- 301(c) Stick measurement legal
- 307(c) Equipment measurement (legal)
- 308(c) Use of electronic devices
- 601(b) Abuse of officials and other misconduct
- 601(g) Alcohol, tobacco, smoking on bench
- 610(h) Continued incorrect players on ice
- 633(a) Refusing to start play
- 633(b) Refusing to go on ice

Minor or Double Minor Penalty

- 640(a) Unnecessary roughness

Minor or Major (major plus game misconduct required if resulting in injury)

- 604(c) Body-checking in Body Contact category or non-check Adult classification
- 609(a) Cross-checking
- 611(a) Elbowing
- 621(a) High-sticking
- 623(a) Hooking
- 628(a) Kneeing
- 634(a) Slashing
- 639(a) Tripping/Clipping/Leg Checking
- 640(b) Avoidable check
- 640(c) Checking opponent after whistle

Minor plus Misconduct or Major plus Game Misconduct

- 603(a) Boarding
- 607(a,c) Charging
- 608(a) Checking from behind
- 620(a,b) Head Contact

Major plus Game Misconduct

- 606(a) Butt-ending
- 608(b) Checking From Behind (head first)
- 615(a,b) Fighting
- 619(a) Head-butting
- 622(b) Holding/grabbing facemask
- 627(a) Push off opponent with skate
- 629(a) Leaving Bench in Altercation
- 635(a) Spearing

Minor, Double Minor or Major plus Game Misconduct

- 615(a) Fighting (retaliation)

Minor plus Misconduct Penalty

- 301(d) Not surrendering stick for measurement

Minor plus Game Misconduct Penalty

- 615(a) Drop glove(s)/stick, instigate altercation

Bench Minor or Game Misconduct or both

- 629(d) Team Official on ice without permission

Match Penalty Option

- 603(c) Boarding
- 606(b) Butt-ending
- 607(e) Charging
- 608(c) Checking from behind
- 615(c) Deliberately removing helmet during altercation
- 619(b) Head-butting
- 620(c) Head Contact
- 622(c) Holding/grabbing facemask

Match Penalty (only)

- 305(b) Taped hand, cutting opponent
- 601(f) Abuse of officials and other misconduct
- 602(a) Deliberate or attempt to injure opponent or team official
- 615(c) Removing helmet prior to or during an altercation (all Youth and Girls'/Women's classifications)
- 627(b) Kicking opponent
- 633(a,b) Suspended game—refusal to start play

Misconduct Penalty

- 304(g) Equipment violation (after warning)
- 305(b) Playing with cut palm on glove
- 406(d) Distraction during penalty shot
- 601(a) Persisting in unsportsmanlike conduct
- 601(c) Abuse of officials and other misconduct

Game Misconduct Penalty

- 401(b) Five penalties to same player in game
- 403(b) Second major penalty in same game
- 404(a) Second misconduct penalty during same game
- 601(a) Persisting in unsportsmanlike conduct
- 601(e) Abuse of officials and other misconduct
- 615(c) Removing helmet prior to or during an altercation (Adult Male classifications)
- 615(d) First to intervene in altercation
- 626(c) Player interference with spectator

Misconduct or Game Misconduct Penalty

- 601(d) Abuse of officials and other misconduct
- 637(c) Stick thrown out of playing area

Game Misconduct or Match Penalty

- 634(c) Swinging stick at opponent in altercation

Penalty Shot (only)

- 205(e) Deliberate illegal substitution
- 610(e) Goalkeeper deliberately displaces goal, no breakaway
- 610(f) Deliberate removal of helmet/facemask, breakaway
- 629(c) Illegal entry, breakaway
- 637(b) Thrown stick, breakaway

Penalty Shot or Awarded Goal

- 610(e) Deliberate goal displacement in scoring opportunity
- 614(b) Player falling on puck in crease
- 616(b,c) Fouled from behind on breakaway
- 618(a) Player picking up puck from crease
- 637(a,b) Stick thrown at puck in Defending Zone

Awarded Goal (only)

- 610(e) Deliberate goal displacement preventing a goal
- 625(c) Goalkeeper stick left in front of goal, preventing a goal

APPENDIX II
SUMMARY OF
FACE-OFF LOCATIONS



Center Ice Spot

- 612(a) Start of game and periods
- 612(a) Goal scored
- 612(a) Premature goalkeeper substitution (normal)

Neutral Zone Spot

- 409(a.2) Coincident icing and delayed penalty
- 612(c) Stoppage by attacking player in Attacking Zone
- 612(c) Attacking player shoots puck onto netting
- 612(d) Gathering of players
- 625(b) Goal crease violation
- 630(c) Puck carried off-side
- 630(e) Off-side error by officials
- 631(d) Attacking team makes puck unplayable

End Zone Face-Off Spot

- 406(c) Unsuccessful penalty shot attempt
- 612(b) Last play face-off between end spots and end boards
- 612(b) Defending player shoots puck onto netting
- 612(f) Goal illegally scored off official
- 618(c) Goalkeeper throws puck forward
- 621(c) High-sticked puck
- 621(d) Slap shot, 10 & under and younger
- 624(a) Icing
- 624(c) Icing error by officials
- 630(c) Intentional off-side

Last Play Face-Off

- 205(b) Premature goalkeeper substitution (exception)
- 409(a) Penalty on team in possession
- 409(a) Stoppage following delayed penalty signal
- 612(b) Fouls by players on both sides simultaneously
- 612(b) General rule
- 618(a) Hand pass
- 626(a,b) Interference by spectators
- 629(e) Off-side player entering from players' bench
- 630(c) Puck passed off-side
- 631(a) Puck strikes overhead obstruction/rink defect
- 632(a) Stalled puck between opposing players
- 632(a) Puck out of sight of Referee

APPENDIX III
OFFICIAL SIGNALS



BOARDING

Striking the closed fist of the hand once into the open palm of the other hand.

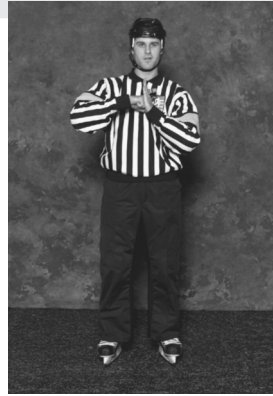

BODY CHECKING

(Body Contact categories and Non-Check Adult classifications)

The palm of the non-whistle hand is brought across the body and placed on the opposite shoulder.



BUTT-ENDING

Moving the forearm, fist closed, under the forearm of the other hand held palm down.

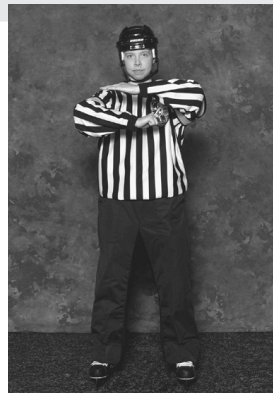

CHARGING

Rotating clenched fists around one another in front of the chest.



CHECKING FROM BEHIND

Arm placed behind the back, elbow bent, forearm parallel to the ice surface.



CROSS-CHECKING

A forward motion with both fists clenched, extending from the chest.



DELAYED CALLING OF PENALTY

The non-whistle hand is extended straight above the head.



DELAYED WHISTLE (SLOW WHISTLE)

(Blue-Line Off-Sides, Delayed Off-Side Classifications Only)

The non-whistle hand is extended straight above the head. If play returns to the Neutral Zone without stoppage, or as soon as the offending team clears the zone, the arm is drawn down.



DELAYING THE GAME

The non-whistle hand, palm open, is placed across the chest and then fully extended directly in front of the body.



ELBOWING

Tapping the elbow with the opposite hand.



FIGHTING (ROUGHING)

One punching motion to the side with the arm extending from the shoulder.



GOAL SCORED

A single point, with the non-whistle hand, directly at the goal in which the puck legally entered, while simultaneously blowing the whistle.



HAND PASS

The non-whistle hand (open hand) and arm are placed straight down alongside the body and swung forward and up once in an underhand motion.

**HEAD CONTACT**

Non-whistle hand placed palm inward on the back of the helmet.

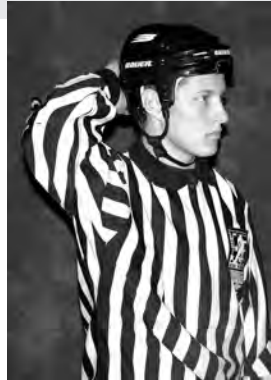
**HIGH-STICKING**

Holding both fists clenched, one immediately above the other, at the side of the head.



HOLDING

Clasping the wrist of the whistle hand well in front of the chest.



HOLDING THE FACEMASK

Closed fist held in front of the face, palm in and pulled down in one straight motion.



HOOING

A tugging motion with both arms, as if pulling something toward the stomach.



ICING

When the puck is shot or deflected in such a manner as to produce a possible icing situation, the back linesman will signal to his partner by raising his non-whistle hand over his head (same as Slow Whistle). The instant that the conditions required to establish "icing the puck" have occurred, the front linesman will blow his whistle to stop play and raise his non-whistle hand (same as Slow Whistle). The back linesman will give the icing signal by folding his arms across his chest.

**INTERFERENCE**

Crossed arms stationary in front of the chest with fists closed.



KNEEING

A single tap of the right knee with the right hand, keeping both skates on the ice.



MATCH PENALTY

Tap open palm of the hand on top of the head.



MISCONDUCT

Placing of both the hands on hips one time.



PENALTY SHOT

Arms crossed (fists clenched) above the head.

**SLASHING**

One chop of the hand across the straightened forearm of the other hand.

**SPEARING**

A single jabbing motion with both hands together, thrust forward from in front of the chest, then dropping hands to the side.



TIME-OUT OR UNSPORTSMANLIKE CONDUCT

Using both hands to form a “T.”



TRIPPING/CLIPPING/LEG CHECKING

Strike the side of the knee and follow through once, keeping the head up and both skates on the ice.



“WASHOUT”

Both arms swung laterally across the body at shoulder level with palms down.

- 1) When used by the Referee, it means no goal or violation so play shall continue.
- 2) When used by the Linesmen, it means there is no icing, off-side, hand pass or high sticking violation.



APPENDIX IV
OFFICIAL RINK
DIAGRAMS



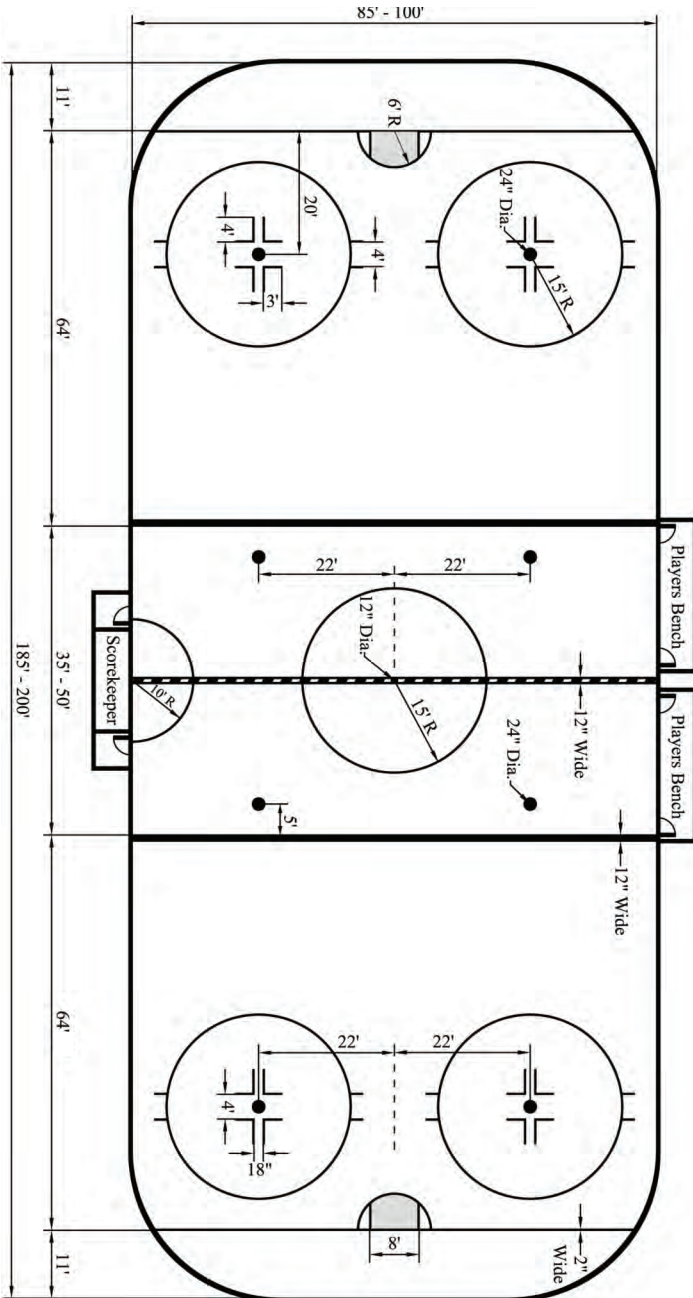

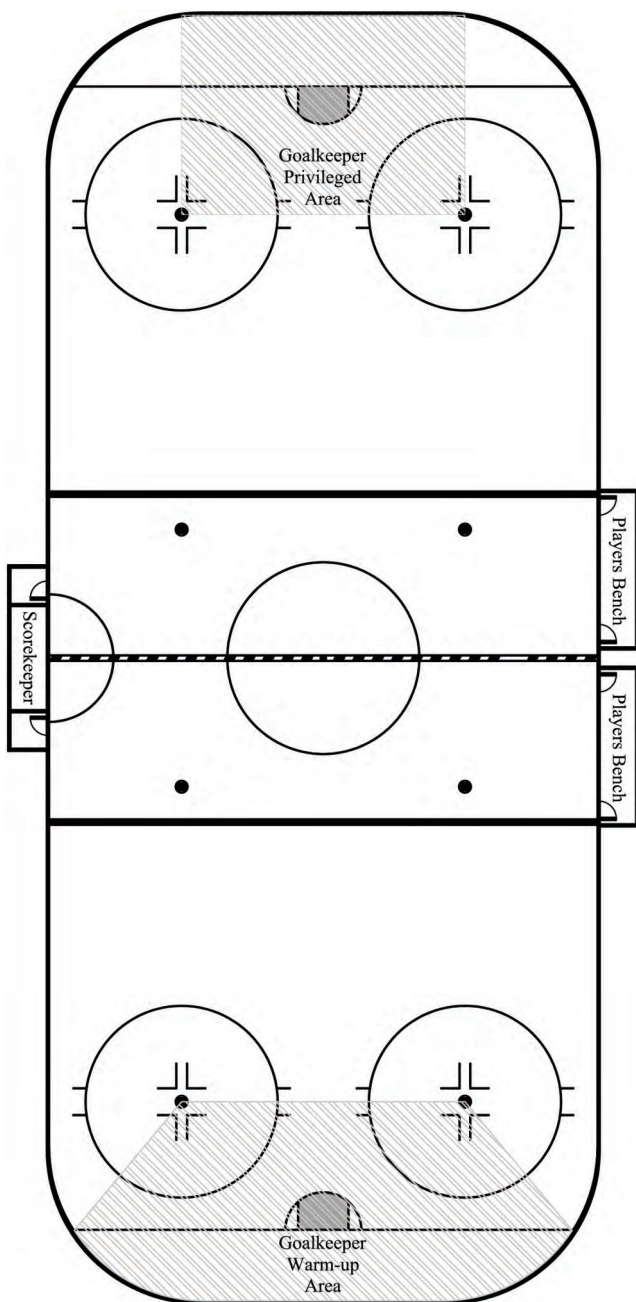

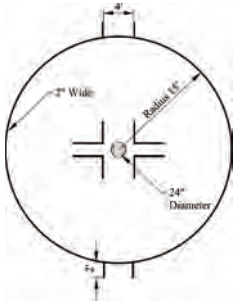

END ZONE FACE-OFF SPOT AND CIRCLE DETAIL

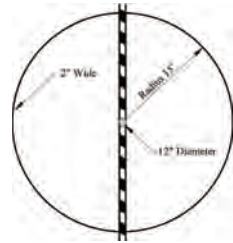

CENTER ICE FACE-OFF SPOT AND CIRCLE DETAIL

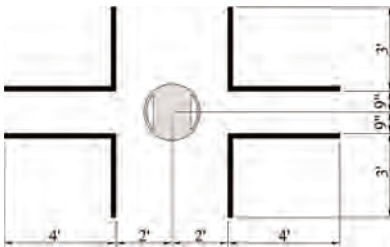

FACE-OFF CONFIGURATION



END ZONE AND NEUTRAL ZONE FACE-OFF SPOTS



GOAL CREASE DETAIL



REFEREE CREASE DETAIL

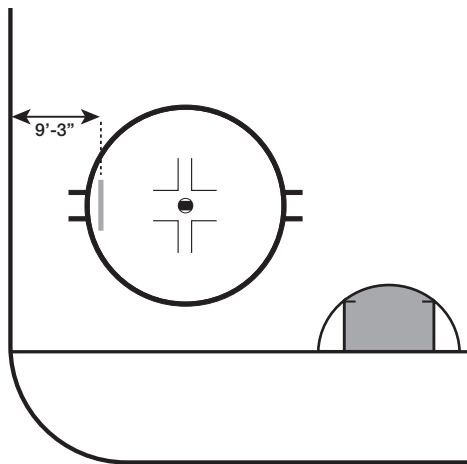

RECOMMENDED CROSS-ICE GOAL LINE

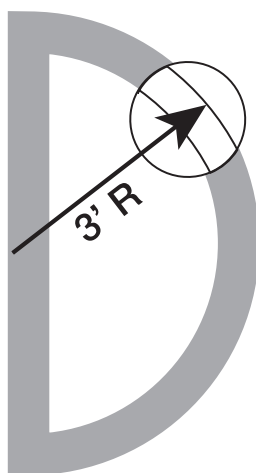
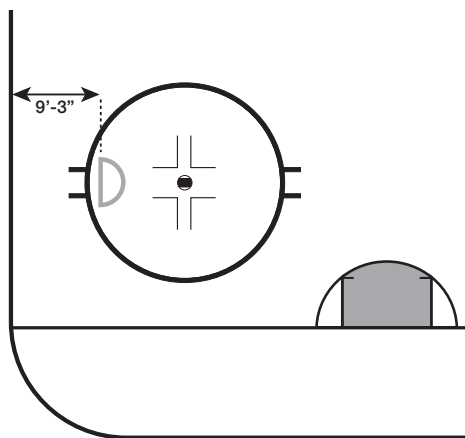

RECOMMENDED CROSS-ICE GOAL CREASE

APPENDIX V
GLOSSARY



Age Classifications

The following Youth and Girls'/Women age classifications have been established for all teams registered with USA Hockey.

Youth Teams: 8 & under (Mite), 10 & under (Squirt), 12 & under (Pee Wee), 14 & under (Bantam), 16 & under (Midget) and 18 & under (Midget).

Girls'/Women Teams: 8 & under, 10 & under, 12 & under, 14 & under, 16 & under and 19 & under.

(Note 1) Girls'/Women playing on a Youth team must conform to the Youth age classification.

(Note 2) High School age classification is governed under the same playing rules as the Youth 18 & under (Midget) age classification.

(Note 3) Adult classifications shall include Adult non-check, Adult U.S., Adult Elite and Adult Women, and shall be governed by these rules, except where otherwise noted.

Altercation

Any physical interaction between two or more opposing players resulting in a penalty or penalties being assessed.

Body Checking

A legal body check is one in which a player checks an opponent who is in possession of the puck, by using his hip or body from the front, diagonally from the front or straight from the side.

Legitimate body checking must be done for the purpose of separating the opponent from the puck, only with the trunk of the body (hips and shoulders) and must be above the opponent's knees and at or below the shoulders.

Body Contact

Contact that occurs between opponents during the normal process of playing the puck, provided there has been no overt hip, shoulder or arm contact to physically force the opponent off of the puck.

Breakaway

A condition whereby a player is in control of the puck with no opposition between the player and the opposing goal, with a reasonable scoring opportunity.

Butt-Ending

The condition whereby a player uses the shaft of the stick above the upper hand to jab or attempt to jab an opposing player.

Coach

A Coach is a person primarily responsible for directing and guiding the play of his team. Along with the Manager, he is responsible for the conduct of his team's players before, during and after a game.

Coincident Penalty

A penalty of equal type (e.g., minor or major) assessed during the same stoppage of play, and for which neither team is reduced in on-ice numerical strength. A coincident penalty never causes either team to be "shorthanded" for purposes of penalty termination if a goal is scored.

Creases

Goalkeeper's-Areas marked on the ice in front of each goal designed to protect the goalkeepers from interference by attacking players.

Referee's-Area marked on the ice in front of the Penalty Timekeeper's seat for the use of the Referee.

Cross-Checking

When a player, holding his stick with both hands, checks an opponent by using the shaft of the stick with no part of the stick on the ice.

Delayed Off-Side

A situation where an attacking player has preceded the puck across the attacking blue line, but the defending team has gained possession of the puck and is in a position to bring the puck out of their Defending Zone without any delay or contact with an attacking player.

Deflecting the Puck

The action of the puck contacting any person or object, causing it to change direction.

Directing the Puck

The act of intentionally moving or positioning the body, skate or stick so as to change the course of the puck in a desired direction.

Face-Off

The action of an official dropping the puck between the sticks of two opposing players to start play. A face-off begins when the Referee indicates its location and the officials take their appropriate positions, and ends when the puck has been legally dropped.

Fighting

The actual throwing of a punch (closed fist) by a player that makes contact with an opponent.

Game Suspension(s)

When a player, Coach or Manager receives a game suspension(s), he shall not be eligible to participate in the next game(s) that was already on the schedule of his team at the time of the incident.

Goalkeeper

A goalkeeper is a person designated as such by a team who is permitted special equipment and privileges to prevent the puck from entering the goal.

Goalkeeper's Privileged Area

The area outlined by connecting the end zone face-off spots with an imaginary line and imaginary lines perpendicular to the end boards (see rink diagram).

Goalkeeper's Warm-Up Area

The area including the Goalkeeper's Privileged Area extended to include the area formed by a line from each end zone face-off spot to where the goal line meets the side boards (see rink diagram).

Head-Butting

The physical use of one's head in the course of delivering a body-check (head first) in the chest, head, neck or back area or the physical use of the head to strike an opponent.

Head Contact

The action of a player contacting an opponent in the head, face or neck, including with the stick or any part of the player's body or equipment.

HECC

The Hockey Equipment Certification Council is an independent organization responsible for the development, evaluation and

testing of performance standards for protective ice hockey equipment. To date, there are standards for facemasks, helmets and goalkeeper head protection.

Heel of the Stick

The point where the shaft of the stick and the bottom of the blade meet.

Hooking

The action of applying the blade of the stick to any part of an opponent's body or stick and impeding his progress by a pulling or tugging motion with the stick.

Injury Potential Penalties

Injury Potential Penalties include Boarding, Body Checking (Body Contact Classifications), Butt-Ending, Charging, Checking from Behind, Cross-Checking, Elbowing, Head-Butting, Head Contact, High Sticking, Holding the Facemask, Kicking, Kneeing, Roughing, Slashing and Spearing. The Linesman may report such infractions to the Referee, following the next stoppage of play, that have occurred behind the play and were unobserved by the Referee.

Last Play Face-Off

The location at which the puck was last legally played by a player or goalkeeper immediately prior to a stoppage of play.

Off-Ice (Minor) Official

Officials appointed to assist in the conduct of the game including the Official Scorer, Game Timekeeper, Penalty Timekeeper and the two Goal Judges. The Referee has general supervision of the game and full control of all game officials, and in case of any dispute the Referee's decision shall be final.

Penalty

A penalty is the result of an infraction of the rules by a player or team official. It usually involves the removal from the game of the offending player or team official for a specified period of time. In some cases the penalty may be the awarding of a penalty shot on goal or the actual awarding of a goal.

Player

Member of a team physically participating in a game. The goalkeeper is considered a player except where special rules specify otherwise.

Possession of the Puck

The last player or goalkeeper to make contact with the puck. This includes a puck that is deflected off a player or any part of his equipment.

Possession and Control of the Puck

The last player or goalkeeper to make contact with the puck and who is also propelling the puck in a desired direction.

Proper Authorities (Proper Disciplinary Authority)

The governing body of the team or teams involved, as determined by the Affiliate, except:

- (1) In USA Hockey Tournaments and Play-Offs, the body shall be the Discipline Committee of the Tournament or Play-Off.
- (2) In matters relating to assault of an official, the body shall be the Affiliate Association of that team.

Protective Equipment

Equipment worn by players for the sole purpose of protection from injury. Recommended equipment should be commercially manufactured.

Shorthanded

Shorthanded means that a team is below the numerical strength of its opponents on the ice. When a goal is scored against a shorthanded team, the minor or bench minor penalty that terminates automatically is the first such non-coincident penalty (the minor or bench minor penalty then being served with the least amount of time remaining). Thus, if an equal number of players from each team is serving a penalty(s) (minor, bench minor, major or match only), neither team is "shorthanded."

Slashing

The action of striking or attempting to strike an opponent with a stick or of swinging a stick at an opponent with no contact being made. Tapping an opponent's stick is not considered slashing.

Spearing

The action of poking or attempting to poke an opponent with the tip of the blade of the stick while holding the stick with one or both hands.

Substitute Goalkeeper

A designated goalkeeper on the Official Scoresheet who is not then participating in the game.

Team Official

A Team Official is any person on the players' bench who is not on the game scoresheet as an eligible player or goalkeeper. All such persons must be registered in the current season as a Coach with USA Hockey, and must have attained the appropriate certification level as required by the District and/or Affiliate. One such person must be designated as the Head Coach. A player or goalkeeper on the roster who is unable to play, other than through suspension, may be on the players' bench without being considered a Team Official if he is wearing the team jersey and all required head and face protective equipment.

Temporary Goalkeeper

A player not designated as a goalkeeper on the Official Scoresheet who assumes that position when no designated goalkeeper is able to participate in the game. He is governed by goalkeeper privileges and limitations and must return as a "player" when a designated goalkeeper becomes available to participate in the game.

Time-Out (Curfew Definition)

A curfew game is one in which the game must end by a certain time of day. Conversely, a non-curfew game is one that will be played to clock time conclusion, regardless of how long the game lasts.

RULE REFERENCES



Abuse of Officials and Other Misconduct	Section 6	Rule 601
Adjustment to Clothing and Equipment	Section 3	Rule 309
Appointment of Officials	Section 5	Rule 501
Attempt to Injure	Section 6	Rule 602
Boarding	Section 6	Rule 603
Body Checking (<i>Body Contact Categories</i>)	Section 6	Rule 604
Broken Stick	Section 6	Rule 605
Butt-Ending	Section 6	Rule 606
Calling of Penalties	Section 4	Rule 409
Captain of Team	Section 2	Rule 202
Change of Players	Section 2	Rule 205
Charging	Section 6	Rule 607
Checking from Behind	Section 6	Rule 608
Clipping	Section 6	Rule 639
Composition of Teams	Section 2	Rule 201
Cross-Checking	Section 6	Rule 609
Dangerous Equipment	Section 3	Rule 305
Delayed Penalties	Section 4	Rule 408
Deliberate Injury of Opponents	Section 6	Rule 602
Delaying the Game	Section 6	Rule 610
Dimensions of Rink	Section 1	Rule 102
Division of Ice Surface	Section 1	Rule 103
Elbowing	Section 6	Rule 611
Electronic Devices	Section 3	Rule 308
Equipment Measurement	Section 3	Rule 307
Face-Off Locations	Section 6	Rule 612
Face-Off Procedures	Section 6	Rule 613
Face-Off Spots and Face-Off Circles	Section 1	Rule 104
Falling on Puck	Section 6	Rule 614
Fighting	Section 6	Rule 615
Fouled from Behind	Section 6	Rule 616
Game Timekeeper	Section 5	Rule 506
Goal Judge	Section 5	Rule 504
Goalkeeper's Equipment	Section 3	Rule 303
Goalkeeper Penalties	Section 4	Rule 407
Goals	Section 1	Rule 105
Goals and Assists	Section 6	Rule 617
Handling Puck with Hands	Section 6	Rule 618
Head-Butting	Section 6	Rule 619
Head Contact	Section 6	Rule 620

RULE REFERENCES

High Sticks	Section 6	Rule 621
Holding an Opponent	Section 6	Rule 622
Hooking	Section 6	Rule 623
Icing the Puck	Section 6	Rule 624
Injured Players	Section 2	Rule 206
Interference	Section 6	Rule 625
Interference by Spectators	Section 6	Rule 626
Kicking Opponent or Puck	Section 6	Rule 627
Kneeing	Section 6	Rule 628
Leaving the Players' Bench or Penalty Bench	Section 6	Rule 629
Leg Checking	Section 6	Rule 639
Linesman	Section 5	Rule 503
Major Penalties	Section 4	Rule 403
Match Penalties	Section 4	Rule 405
Minor Penalties	Section 4	Rule 402
Misconduct Penalties	Section 4	Rule 404
Official Scorer	Section 5	Rule 505
Off-Sides	Section 6	Rule 630
Penalties	Section 4	Rule 401
Penalty Bench	Section 1	Rule 107
Penalty Shot	Section 4	Rule 406
Penalty Timekeeper	Section 5	Rule 507
Players' Bench	Section 1	Rule 106
Players in Uniform	Section 2	Rule 203
Playing Lineup	Section 2	Rule 204
Progressive Suspensions	Section 4	Rule 411
Proper Authorities	Section 5	Rule 508
Protective Equipment	Section 3	Rule 304
Puck	Section 3	Rule 306
Puck Out of Bounds or Unplayable	Section 6	Rule 631
Puck in Motion or Out of Sight	Section 6	Rule 632
Referee	Section 5	Rule 502
Refusing to Start Play	Section 6	Rule 633
Rink	Section 1	Rule 101
Roughing	Section 6	Rule 640
Signal and Timing Devices	Section 1	Rule 108
Skates	Section 3	Rule 302
Slashing	Section 6	Rule 634
Spearing	Section 6	Rule 635
Start of Game	Section 6	Rule 636

Sticks	Section 3	Rule 301
Supplementary Discipline	Section 4	Rule 410
Throwing Stick/Object	Section 6	Rule 637
Tied Games	Section 6	Rule 638
Time of Match.	Section 6	Rule 636
Time-Outs	Section 6	Rule 636
Tripping	Section 6	Rule 639
Unnecessary Roughness	Section 6	Rule 640

The Ultimate Authority

The *Official Rules of Ice Hockey* is the essential resource for players, coaches, referees, parents and fans.

Included are USA Hockey's official playing rules and interpretations, referee signals and detailed rink diagrams.

This book is the singular source for the rules of the game.

